

NOVEDADES

ACTIVA

playtech

MADE IN
EUROPE

Soluciones



Pack DALI Basic 10

ACTIVA

Lámparas



icon basic 20



esSENSE Standard basic 21



esSENSE BALL basic 22



esSENSE Flame basic 23

Imagine: Tiras de led



Imagine Rollo 24V 26



Imagine IP20 28



Imagine IP65 30



Accesorios 34

Downlights

N
NEW



Kentau Avant
CL/SO 38

N
NEW



Kentau Avant
SO 40



Breno CL 42



Accesorios 44

Solar

N
NEW



Vorona Switch 48

Green



Arette Avant 52

N
NEW



Chio Avant Dali 56

N
NEW



Akagy Switch 58

N
NEW



Akagy Basic 60



Kenia 62



Accesorios 64

Proyectores

Industrial

N
NEW



Ákora HE 68

N
NEW



Ákora Switch 70



Accesorios 72

City

N
NEW



Dorna 76

playtech

City



Nebira 82

Spaces



Silaya IP65 90



Altha 92



Altha L 98



Accesorios 100

MADE IN EUROPE

ACTIVA

Lámparas



Berran 108



Reviat 108



Galai 108



Reinet 108

Apliques Lineales

N
NEW



Lynx Basic 112

Downlights

N
NEW



Geltax G2 116

N
NEW



Sorat 118

N
NEW



Velium 120

N
NEW



Vexis M 122

N
NEW



Neota M 124

Pantallas

N
NEW



Exania CL 128

N
NEW



Exania CL Plus 128

N
NEW



Exania RE Direct 128

N
NEW



Exania SQ Direct 128

City



Sonis 132

Industrial



Naxos 136

MADE IN EUROPE

playtech

City



Ilunox 140



Voxel 142

Industrial



Kynek 146



Exon G2 148



Exon OD G2 150



Exon FR G2 152



Exon IN G2 154



Diasora 156

Spaces

N
NEW



Lynx Superficie 160

N
NEW



Lynx Empotrar 160

N
NEW



Lynx Óptima 164

N
NEW



Lynx Óptima Modular 166

Anexos

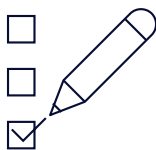

Certificaciones 168



Condiciones de Uso 168



Condiciones de Garantía 168



Condiciones de Venta 168

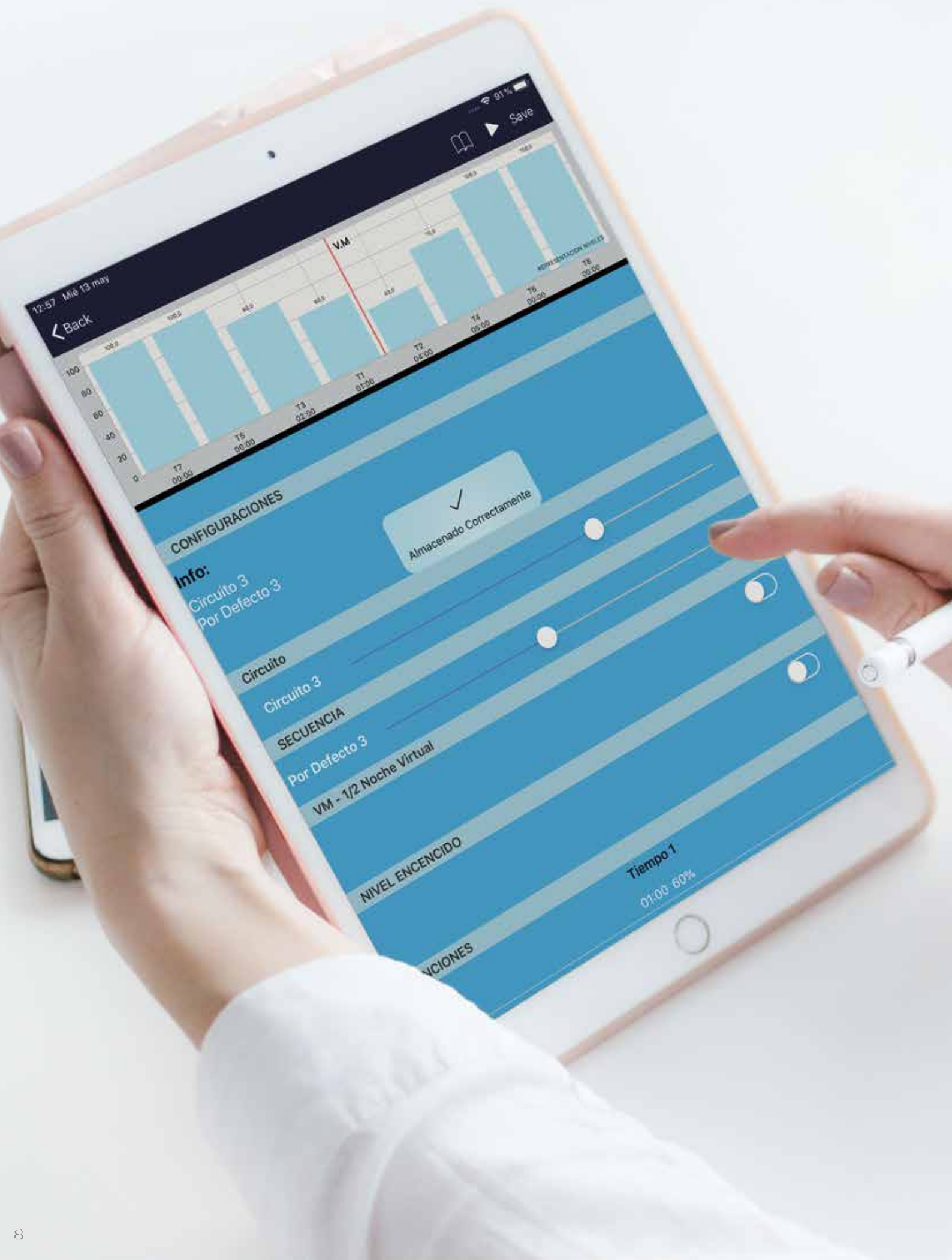

12:57 Mie 13 may

Back

Save

CONFIGURACIONES

✓
Almacenado Correctamente

Info:
Circuito 3
Por Defecto 3

Circuito

Circuito 3

SECUENCIA

Por Defecto 3

VM - 1/2 Noche Virtual

NIVEL ENCENDIDO

Tiempo 1

01:00 60%

Soluciones

Solutions
Des solutions
Soluções

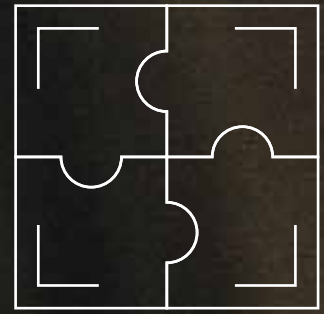

Pack DALI Basic

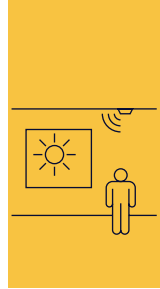

Ñ

El Pack DALI Basic Prilux es un dispositivo de control y multisensor que regula en función de la luz natural y opcionalmente de la presencia, en hasta 3 niveles, dependiendo del movimiento detectado.

Indicado para instalaciones de hasta 15 equipos con una salida DALI broadcast. Dispone de una entrada de pulsador convencional para el manejo y calibración sencilla, con tan solo una pulsación y también opción de manejo y calibración mediante mando a distancia (no incluido en el kit).

Dispositivo apto para cumplir con las exigencias del apartado HE3 del CTE.

F

Le Prilux DALI Basic Pack est un dispositif de contrôle et de multi-capteurs qui régule en fonction de la lumière du jour et, en option, de la présence, jusqu'à 3 niveaux, en fonction du mouvement détecté.

Il est adapté aux installations jusqu'à 15 unités avec une sortie de diffusion DALI. Il dispose d'une entrée conventionnelle à bouton-poussoir pour un fonctionnement et un calibrage simples, d'une seule touche, ainsi que de l'option de fonctionnement et de calibrage par télécommande (non incluse dans le kit).

E

The Prilux DALI Basic Pack is a control and multi-sensor device that regulates according to daylight and optionally presence, in up to 3 levels, depending on movement detected.

Suitable for installations of up to 15 units with a DALI broadcast output. It has a conventional temporary push-button input for simple handling and calibration, with just one push, and also the option of handling and calibration by remote control (not included in the kit).

Device suitable for compliance with the requirements of section HE3 of the CTE (Technical Building Code).

P

O Pack DALI Basic da Prilux é um dispositivo de controlo e multi-sensor que regula em função da luz do dia e, opcionalmente, da presença, até 3 níveis, em função do movimento detectado.

Adequado para instalações até 15 unidades com uma saída do tipo DALI. Dispõe de uma entrada de botão de pressão convencional para um funcionamento e calibração simples, por toque, e também a opção de funcionamento e calibração através de controlo remoto (não incluído no kit).

Dispositivo adequado para o cumprimento das normas nacionais. Eficiência energética em edifícios.



Funcionalidades

Functionalities / Fonctionnalités / Funcionalidades

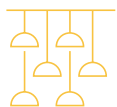

Control y multisensor (luminosidad y presencia) DALI para hasta 15 luminarias.

DALI control and multi-sensor (brightness and presence) for up to 15 luminaires.

Contrôle DALI et multi-capteurs (luminosité et présence) pour un maximum de 15 luminaires.

Controlo DALI e multi-sensor (luminosidade e presença) para um máximo de 15 luminárias.



Regulación automática de flujo en función de la luz natural.

Automatic flux regulation according to natural light.

Régulation automatique du flux en fonction de la lumière naturelle.

Regulação automática do fluxo em função da luz natural.



Detección de presencia en hasta 3 niveles programable a través del multi-sensor incorporado.

Presence detection in up to 3 programmable levels via the built-in multi-sensor.

Détection de présence jusqu'à 3 niveaux programmables grâce au multi-capteur intégré.

Detecção de presença em até 3 níveis programáveis através do multi-sensor incorporado.



Función CLO: Compensando en factor de mantenimiento.

CLO function: Compensating in maintenance factor.

Fonction CLO : compensation du facteur de maintenance.

Função CLO: Compensação do fator de manutenção.



Fácil instalación en superficie con entrada de pulsador.

Easy surface installation with temporary push-button input.

Installation facile en saillie grâce à l'entrée par bouton-poussoir.

Fácil instalação à superfície com entrada por botão de pressão.



Calibración con un toque al pulsador o mando a distancia.

One-touch calibration at temporary push-button or remote control

Etalonnage par simple pression d'un bouton-poussoir ou d'une télécommande.

Calibração com um toque no botão de pressão ou no controlo remoto.



Provisto de fotocélula especial para medir y diferenciar la luz natural de la luz LED.

Equipped with a special photocell to measure and differentiate between daylight and LED light.

Équipé d'une cellule photoélectrique spéciale pour mesurer et différencier la lumière du jour de la lumière LED.

Equipado com uma fotocélula especial para medir e diferenciar a luz do dia da luz LED.



Aprendizaje luz natural con mando a distancia.

Daylight calibration with remote control

Apprentissage de la lumière du jour avec télécommande

Aprendizagem à luz do dia com controlo remoto



Posibilidad de control con mando a distancia. (No incluido en el pack).

Remote control capability (remote not included).

Possibilité de télécommande (non incluse dans le pack).

Possibilidade de controlo remoto (não incluído na embalagem).



Pack DALI Basic

Iluminación de edificio de oficinas
 Offices building lighting
 Éclairage des immeubles de bureaux
 Iluminação de edifícios de escritórios

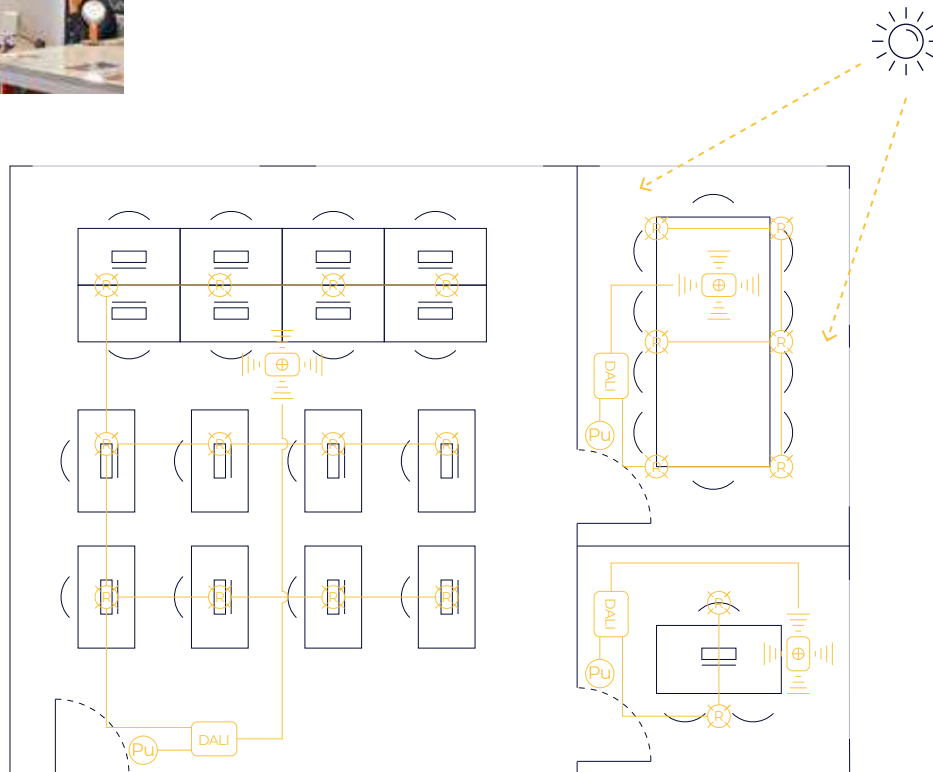

Ñ: Pack DALI Basic Prilux está especialmente indicado para instalaciones de interior, como aulas, oficinas, despachos y similares, además de pasillos, lavabos... Pensado para su instalación en superficie en techos o empotrado, para alturas de techo estándar de 3m.

E: Pack DALI Basic Prilux is particularly suitable for indoor installations, such as classrooms, offices, offices and similar spaces, as well as corridors, restrooms... Designed for surface mounting on ceilings or recessed installation, suitable for standard ceiling heights of 3m.

F: Le Pack DALI Basic Prilux est particulièrement adapté aux installations intérieures, telles que les salles de classe, les bureaux, les bureaux et similaires, ainsi que les couloirs, les toilettes... Conçu pour un montage en saillie dans les plafonds ou une installation encastrée, pour des hauteurs de plafond standard de 3m.

P: O Pack DALI Basic da Prilux é especialmente adequado para instalações interiores, como salas de aula, escritórios, gabinetes e similares, bem como corredores, casas de banho, etc... Concebido para montagem à superfície em tectos com instalação encastrada do driver, para alturas de teto padrão de 3m.



Pulsador
 Push-button
 Bouton poussoir
 Botão de pressão

Mando a distancia
 Remote control
 Télécommande
 Controlo remoto



Componentes

Components / Composants / Componentes



638753

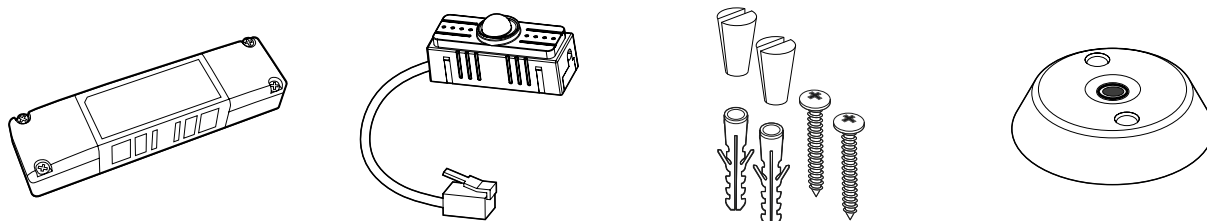

DISPOSITIVO DE CONTROL
CONTROL DEVICE
DISPOSITIF DE CONTRÔLE
DISPOSITIVO DE CONTROL

SENSOR DALI
DALI SENSOR
CAPTEUR DALI
SENSOR DALI

ELEMENTOS DE FIJACIÓN
FIXING ELEMENTS
FIXATIONS
FIXADORES

ACCESORIO DE MONTAJE
MOUNTING ACCESSORY
ACCESSOIRE DE MONTAGE
ACESSORIO DE MONTAGEM

635196

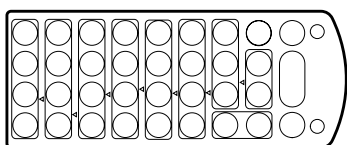

MANDO A DISTANCIA IR DALI BASIC (*NO INCLUIDO)
IR DALI BASIC REMOTE CONTROL (*NOT INCLUDED)
TÉLÉCOMMANDE IR DALI BASIC (*NON INCLUS)
CONTROL REMOTO IR DALI BASIC (*NÃO INCLUIDO)



ACTIVA



Lámparas
lamps
lampes décoratives
lâmpadas



Ñ/ ICON basic regulable: Regulación TRIAC y tradicional de incandescencia. **E/** ICON basic dimmable: TRIAC regulation and traditional incandescent. **F/** ICON basic regulable: Régulation TRIAC et incandescence traditionnelle. **P/** ICON basic regulável: Regulação TRIAC e incandescente tradicional.



GU5.3



GU10



Barcode	Symbol	W _r	⚡	Φ	φ	K	∠	Shield	↕	⌚	
578851	G	6,5W	12V ac	>0,7	600lm	3	3.000K	100°	GU5.3	Ø50 x 48mm	NO
578875	G	6,5W	12V ac	>0,7	600lm	4	4.000K	100°	GU5.3	Ø50 x 48mm	NO
578882	G	6,5W	12V ac	>0,7	600lm	5	5.000K	100°	GU5.3	Ø50 x 48mm	NO
N 634694	G	6,5W	230V ac	>0,5	598lm	27	2.700K	38°	GU10	Ø50 x 58mm	SI
545457	G	6,5W	230V ac	>0,5	578lm	3	3.000K	100°	GU10	Ø50 x 58mm	SI
545464	G	6,5W	230V ac	>0,5	605lm	4	4.000K	100°	GU10	Ø50 x 58mm	SI
545471	G	6,5W	230V ac	>0,5	622lm	5	5.000K	100°	GU10	Ø50 x 58mm	SI
*N 648110	G	6,5W	230V ac	>0,5	561lm	27	2.700K	100°	GU10	Ø50 x 58mm	SI
*N 648127	G	6,5W	230V ac	>0,5	561lm	27	2.700K	100°	GU10	Ø50 x 58mm	NO
378727	F	7W	230V ac	>0,5	578lm	3	3.000K	100°	GU10	Ø50 x 58mm	NO
386326	F	7W	230V ac	>0,5	605lm	4	4.000K	100°	GU10	Ø50 x 58mm	NO
378734	F	7W	230V ac	>0,5	622lm	5	5.000K	100°	GU10	Ø50 x 58mm	NO

Hz	⊙	🌡	🌿	📏
50-60Hz	IP20	-5°C~+35 °C	>80	(L70B50>)25.000h

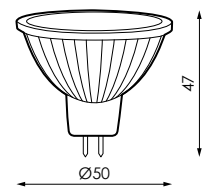

GU5.3

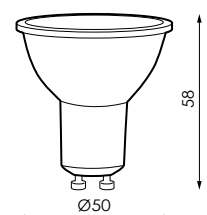

GU10

*Consultar disponibilidad/ *Check availability/ **Vérifier la disponibilité/ **Verificar disponibilidad

esSENSE

Standard basic



5/8,5W



10,5W

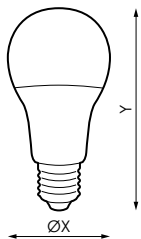

		W_t	ϕ	K			
*N 648028		5W	448lm		2.700K	Ø60 x 102mm	NO
524582		5W	456lm		3.000K	Ø60 x 102mm	NO
524599		5W	472lm		4.000K	Ø60 x 102mm	NO
524605		5W	483lm		5.000K	Ø60 x 102mm	NO
*N 648035		8,5W	833lm		2.700K	Ø60 x 102mm	NO
524612		8,5W	841lm		3.000K	Ø60 x 102mm	NO
524629		8,5W	876lm		4.000K	Ø60 x 102mm	NO
524636		8,5W	903lm		5.000K	Ø60 x 102mm	NO
*N 648172		10,5W	1.002lm		2.700K	Ø60 x 120mm	SI
*N 648141		10,5W	1.018lm		3.000K	Ø60 x 120mm	SI
*N 648158		10,5W	1.039lm		4.000K	Ø60 x 120mm	SI
*N 648165		10,5W	1.067lm		5.000K	Ø60 x 120mm	SI
N 648042		10,5W	1.055lm		2.700K	Ø60 x 120mm	NO
524643		10,5W	1.018lm		3.000K	Ø60 x 120mm	NO
524650		10,5W	1.039lm		4.000K	Ø60 x 120mm	NO
524667		10,5W	1.067lm		5.000K	Ø60 x 120mm	NO

	Hz		ϕ		Δ			
230V ac	50-60Hz	IP20	>0,5	-5°C~+35 °C	220°	>80	E27	(L70B50)>15.000h

*Consultar disponibilidad/ *Check availability/ **Vérifier la disponibilité/ **Verificar disponibilidad

esSENSE

Ball basic



Barcode	Color	W _r	Φ	K	Base	Dimensions
*N 648226	F	5W	470lm	27	2.700K	E14 Ø45 x 82mm
524711	F	5W	493lm	3	3.000K	E14 Ø45 x 78mm
524728	F	5W	501lm	4	4.000K	E14 Ø45 x 78mm
524735	F	5W	511lm	5	5.000K	E14 Ø45 x 78mm
*N 648233	F	5W	470lm	27	2.700K	E27 Ø45 x 77mm
524551	F	5W	493lm	3	3.000K	E27 Ø45 x 74mm
524568	F	5W	501lm	4	4.000K	E27 Ø45 x 74mm
524575	F	5W	511lm	5	5.000K	E27 Ø45 x 74mm

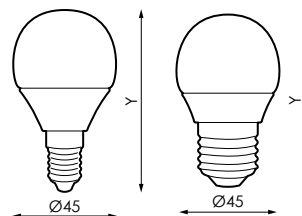

E14

E27

Voltage	Frequency	Protection	Power Factor	Temp. Range	Beam Angle	Life Span	Dimming
230V ac	50-60Hz	IP20	>0,5	-5°C~+35 °C	240°	>80	(L70B50>)15.000h









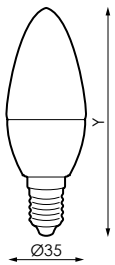











*Consultar disponibilidad/ *Check availability/ **Verificar la disponibilidad/ **Verificar disponibilidad

esSENSE

Flame basic



		W_r	ϕ	K	
*N 648240		5W	470lm		2.700K Ø35 x 103mm
524513		5W	489lm		3.000K Ø35 x 102mm
524520		5W	501lm		4.000K Ø35 x 102mm
524544		5W	506lm		5.000K Ø35 x 102mm

	Hz		Φ					
230V ac	50-60Hz	IP20	>0,5	-5°C~+35 °C	280°	>80	E14	(L70B50->)15.000h



*Consultar disponibilidad/ *Check availability/ *Vérifier la disponibilité/ *Verificar disponibilidad



Imagine: Tiras de led

Imagine: Led strips

Imagine: Rubans led

Imagine: Tiras de led



TAPAS FOOD/DRINKS

0681 39

Imagine IP20

Rollo/ Roll/ Rouleau/ Rollo



	W_T	ϕ		K				
*649438	14,4W	1.438lm/m	4	4.000K	>80	5cm	40.000 x 10mm	40m
	Hz			Δ				
24V dc	50-60Hz	CIII	IP20	120°	(L70B50>) 50.000h			

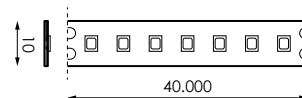

Imagine IP65

Rollo/ Roll/ Rouleau/ Rollo



	W_T	ϕ		K				
*651523	14,4W	1.482lm/m	4	4.000K	>80	5cm	30.000 x 10mm	30m
	Hz			Δ				
24V dc	50-60Hz	CIII	IP65	120°	(L70B50>) 50.000h			

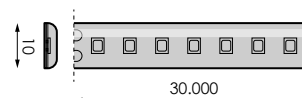

*Consultar disponibilidad/ *Check availability/ **Vérifier la disponibilité/ **Verificar disponibilidad



Iglesia San Felipe Neri
Madrid

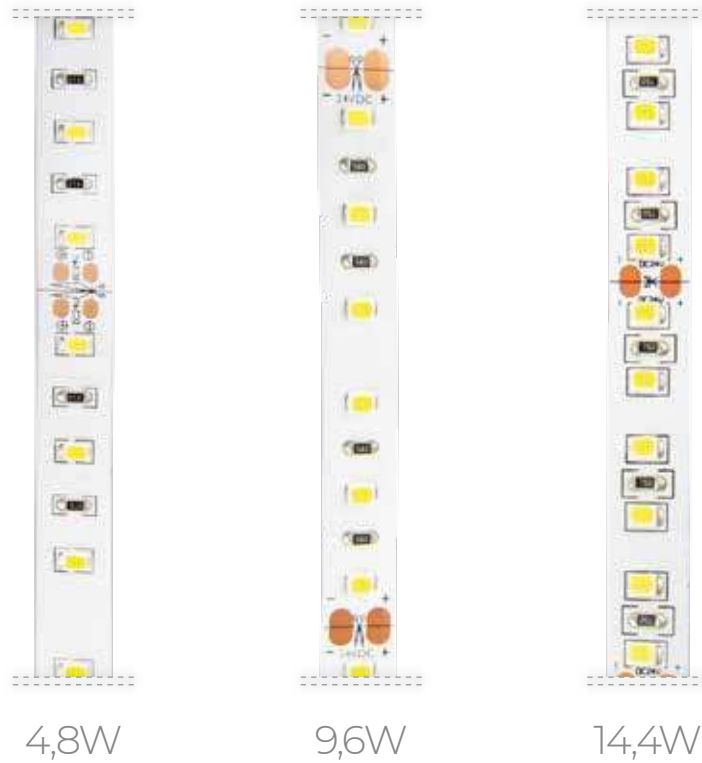

	Hz				
24V dc	50-60Hz	CIII	IP20	120°	(L70B50-) 50.000h

AVISO / WARNING / AVERTISSEMENT / AVISO

Ñ/ Pérdida de intensidad para más de 10m (4,8W/m-9,6W/m-14,4W/m).

La vida útil de nuestras tiras de led es de 50.000h siempre que la temperatura ambiente no supere los 25°C.

Con el fin de garantizar la vida del led para nuestras tiras $\geq 9,6W$, es obligatorio colocarlo sobre una superficie que disipe el calor que generan.

E/ >10m diminished performance (4,8W/m-9,6W/m-14,4W/m).

The life time of our LED strips is 50.000h as long as the ambient temperature does not exceed 25°C.

To ensure the life of the LED for our strips $\geq 9,6W$, it is mandatory to place it on a surface that dissipates the heat they generate.

F/ >10m moins de performance (4,8W/m-9,6W/m- 14,4W/m).

La durée de vie de nos bandes de LED est de 50.000h, à condition que la température ambiante ne dépasse pas 25°C.

Afin de garantir la durée de vie des LED de nos barrettes $\geq 9,6W$, il est impératif de les placer sur une surface qui dissipe la chaleur qu'elles génèrent.

P/ Perde intensidade para instalações >10m (4,8W/m-9,6W/m- 14,4W/m).

A vida útil das nossas fitas LED é de 50.000h, desde que a temperatura ambiente não exceda 25°C.

Para garantir a vida útil do LED para nossas tiras $\geq 9,6 W$, é obrigatório colocá-lo em uma superfície que dissipe o calor gerado.



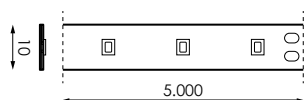

Imagine IP20 4,8W



	W_T	ϕ_T	K			
470810	4,8W	454lm/m	2,7 2.700K	>80	10cm	5.000x10mm
568456	4,8W	454lm/m	2,7 2.700K	>80	10cm	5.000x10mm
*N 651547	4,8W	469lm/m	3 3.000K	>80	10cm	5.000x10mm
568463	4,8W	480lm/m	4 4.000K	>80	10cm	5.000x10mm
470834	4,8W	496lm/m	5 5.000K	>80	10cm	5.000x10mm
568470	4,8W	496lm/m	5 5.000K	>80	10cm	5.000x10mm
N 568487	4,8W	503lm/m	6,5 6.500K	>80	10cm	5.000x10mm

Imagine IP20 9,6W



	W_T	ϕ_T	K			
568494	9,6W	871lm/m	2,7 2.700K	>80	7,1cm	5.000x10mm
*N 651554	9,6W	1168lm/m	3 3.000K	>80	7,1cm	5.000x10mm
568500	9,6W	910lm/m	4 4.000K	>80	7,1cm	5.000x10mm
568517	9,6W	960lm/m	5 5.000K	>80	7,1cm	5.000x10mm
568524	9,6W	993lm/m	6,5 6.500K	>80	7,1cm	5.000x10mm

Imagine IP20 14,4W

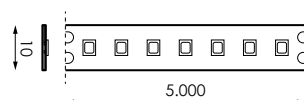

	W_T	ϕ_T	K			
568531	14,4W	1.423lm/m	2,7 2.700K	>80	5cm	5.000x10mm
*N 651561	14,4W	1551lm/m	3 3.000K	>80	5cm	5.000x10mm
568548	14,4W	1.482lm/m	4 4.000K	>80	5cm	5.000x10mm
568579	14,4W	1.512lm/m	5 5.000K	>80	5cm	5.000x10mm
568586	14,4W	1.568lm/m	6,5 6.500K	>80	5cm	5.000x10mm
568609	14,4W	1.431lm/m	4 4.000K	>90	5cm	5.000x10mm

*Consultar disponibilidad/ *Check availability/ *Vérifier la disponibilité/ *Verificar disponibilidad

Imagine

IP20

Hasta 5 años garantía ver condiciones
Up to 5 years warranty see conditions
Jusqu'à 5 ans de garantie voir conditions
Até 5 anos de garantia ver condições







19,2W



24,5W



	Hz				
24V dc	50-60Hz	CIII	IP20	120°	(L70B50-) 50.000h



Imagine IP20 19,2W

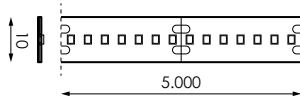

	W_T	ϕ_T	K			
568616	19,2W	2.112lm/m	2,7	2.700K	>90	5.000x10mm
*N 651677	19,2W	2.089lm/m	3	3.000K	>90	5.000x10mm
568630	19,2W	2.112lm/m	4	4.000K	>90	5.000x10mm
568647	19,2W	2.112lm/m	5	5.000K	>90	5.000x10mm
568654	19,2W	2.112lm/m	6,5	6.500K	>90	5.000x10mm

Imagine IP20 24,5W

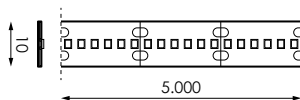

	W_T	ϕ_T	K			
568661	24,5W	2.695lm/m	2,7	2.700K	>90	5.000x10mm
*N 651684	24,5W	2.326lm/m	3	3.000K	>90	5.000x10mm
568678	24,5W	2.695lm/m	4	4.000K	>90	5.000x10mm
568685	24,5W	2.695lm/m	5	5.000K	>90	5.000x10mm
568692	24,5W	1.980lm/m	6,5	6.500K	>90	5.000x10mm

AVISO / WARNING / AVERTISSEMENT / AVISO

Ñ/ Pérdida de intensidad para más de 5m (19,2W/m - 19,2W/m WAS - 24,5W/m).

La vida útil de nuestras tiras de led es de 50.000h siempre que la temperatura ambiente no supere los 25°C.

Con el fin de garantizar la vida del led para nuestras tiras $\geq 9,6W$, es obligatorio colocarlo sobre una superficie que disipe el calor que generan.

E/ >5m diminished performance (19,2W/m - 19,2W/m WAS - 24,5W/m).

The life time of our LED strips is 50.000h as long as the ambient temperature does not exceed 25°C.

To ensure the life of the LED for our strips $\geq 9.6W$, it is mandatory to place it on a surface that dissipates the heat they generate.

F/ >5m moins de performance (19,2W/m - 19,2W/m WAS - 24,5W/m).

La durée de vie de nos bandes de LED est de 50.000h, à condition que la température ambiante ne dépasse pas 25°C.

Afin de garantir la durée de vie des LED de nos barrettes $\geq 9,6W$, il est impératif de les placer sur une surface qui dissipe la chaleur qu'elles génèrent.

P/ Perde intensidade para instalações >5m (19,2W/m - 19,2W/m WAS - 24,5W/m).

A vida útil das nossas fitas LED é de 50.000h, desde que a temperatura ambiente não exceda 25°C.

Para garantir a vida útil do LED para nossas tiras $\geq 9,6W$, é obrigatório colocá-lo em uma superfície que dissipe o calor gerado.

*Consultar disponibilidad/ *Check availability/ **Vérifier la disponibilité/ **Verificar disponibilidad

Imagine

IP65

 Hasta 5 años garantía ver condiciones
 Up to 5 years warranty see conditions
 Jusqu'à 5 ans de garantie voir conditions
 Até 5 anos de garantia ver condições



4,8W





9,6W



14,4W



	Hz				
24V dc	50-60Hz	CIII	IP65	120°	(L70B50>) 50.000h



Centro del Ocio
 San Pedro del Pinatar (Murcia)

[GRÁFICOS: Unidades en mm/ GRAPHICS: Units in mm/ GRÁFICOS: Unidades en mm/ GRÁFICOS: Unidades en mm]

Imagine IP65 4,8W

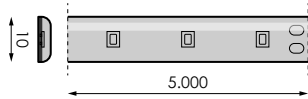

	W_T	ϕ_T	K			
568715	4,8W	454lm/m	2,7	2.700K	>80	10cm 5.000x10mm
*N 651578	4,8W	469lm/m	3	3.000K	>80	10cm 5.000x10mm
471091	4,8W	480lm/m	4	4.000K	>80	10cm 5.000x10mm
568722	4,8W	480lm/m	4	4.000K	>80	10cm 5.000x10mm
568739	4,8W	496lm/m	5	5.000K	>80	10cm 5.000x10mm
568746	4,8W	503lm/m	6,5	6.500K	>80	10cm 5.000x10mm

Imagine IP65 9,6W

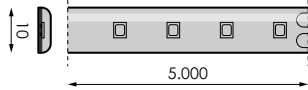

	W_T	ϕ_T	K			
568753	9,6W	871lm/m	2,7	2.700K	>80	7,1cm 5.000x10mm
*N 651585	9,6W	910lm/m	3	3.000K	>80	7,1cm 5.000x10mm
568999	9,6W	910lm/m	4	4.000K	>80	7,1cm 5.000x10mm
569019	9,6W	960lm/m	5	5.000K	>80	7,1cm 5.000x10mm
569026	9,6W	993lm/m	6,5	6.500K	>80	7,1cm 5.000x10mm

Imagine IP65 14,4W

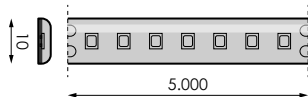

	W_T	ϕ_T	K			
569033	14,4W	1.423lm/m	2,7	2.700K	>80	5cm 5.000x10mm
*N 651592	14,4W	1.551lm/m	3	3.000K	>80	5cm 5.000x10mm
569040	14,4W	1.482lm/m	4	4.000K	>80	5cm 5.000x10mm
569057	14,4W	1.512lm/m	5	5.000K	>80	5cm 5.000x10mm
569064	14,4W	1.568lm/m	6,5	6.500K	>80	5cm 5.000x10mm

AVISO / WARNING / AVERTISSEMENT / AVISO

N/ Pérdida de intensidad para más de 10m.

La vida útil de nuestras tiras de led es de 50.000h siempre que la temperatura ambiente no supere los 25°C.

Con el fin de garantizar la vida del led para nuestras tiras $\geq 9,6W$, es obligatorio colocarlo sobre una superficie que disipe el calor que generan.

E/ >10m diminished performance.

The life time of our LED strips is 50.000h as long as the ambient temperature does not exceed 25°C.

To ensure the life of the LED for our strips $\geq 9.6W$, it is mandatory to place it on a surface that dissipates the heat they generate.

F/ >10m moins de performance.

La durée de vie de nos bandes de LED est de 50.000h, à condition que la température ambiante ne dépasse pas 25°C.

Afin de garantir la durée de vie des LED de nos barrettes $\geq 9,6W$, il est impératif de les placer sur une surface qui dissipe la chaleur qu'elles génèrent.

P/ Perde intensidade para instalações >10m.

A vida útil das nossas fitas LED é de 50.000h, desde que a temperatura ambiente não exceda 25°C.

Para garantir a vida útil do LED para nossas tiras $\geq 9,6W$, é obrigatório colocá-lo em uma superfície que dissipe o calor gerado.

*Consultar disponibilidad/ *Check availability/ *Vérifier la disponibilité/ *Verificar disponibilidad

Accesorios

Accessories

Accessoires

Acessórios

		Imagine IP20	Imagine IP65	
+	472395	•	•	
	001253	•	•	
-	001437	•	•	
	001662	•	•	
	001663	•	•	
	242820	•		
	242837	•		
	473682	•	•	
	473699	•	•	
	487863	•	•	
	487870	•	•	
	487887	•	•	
	487894	•	•	
	473705	•	•	
	501453	•	•	
	-	473040		•
		473057	•	
473064			•	
473071		•		
638333		•		
638326		•		



Regulador Imagine
Imagine regulator
Régulateur Imagine
Regulador Imagine

472395	5~24V dc	1x5A	51 x 14 x 6mm



Fuente de alimentación
Power supply
Source de courant
Fonte de energia

	W			
501453	200W	24V dc	IP67	199 x 63 x 35,5mm



Fuente de alimentación
Power supply
Source de courant
Fonte de energia

	W	⚡	⊙	↕
473682	60W	24V dc	IP67	162,5 x 42,5 x 32mm
473699	100W	24V dc	IP67	190 x 52 x 37mm
473705	150W	24V dc	IP67	191 x 63 x 37,5mm



Fuente de alimentación
Power supply
Source de courant
Fonte de energia

	W	⚡	⊙	↕
242820	150W	24V dc	IP20	205 x 98 x 42mm
242837	250W	24V dc	IP20	205 x 110 x 50mm



Fuente de alimentación DALI
Power supply DALI
Source de courant DALI
Fonte de energia DALI

	W	⚡	⊙	↕
001662	35W	24V dc	IP20	195 x 43 x 30,2mm
001663	60W	24V dc	IP20	225 x 43 x 30,2mm
001253	100W	24V dc	IP20	295 x 43 x 30,2mm
001437	150W	24V dc	IP20	325 x 43 x 30,2mm



Fuente de alimentación BLUETOOTH
Power supply BLUETOOTH
Source de courant BLUETOOTH
Fonte de energia BLUETOOTH

	W	⚡	⊙	↕
487863	35W	24V dc	IP20	195 x 43 x 30,2mm
487870	60W	24V dc	IP20	225 x 43 x 30,2mm
487887	100W	24V dc	IP20	295 x 43 x 30,2mm
487894	150W	24V dc	IP20	325 x 43 x 30,2mm



Conector tira-cable Imagine
Imagine strip-cable connector
Connecteur bande-câble Imagine
Conector tira-cabo Imagine

	⊙	↕
473057	IP20	10mm
473040	IP65	10mm



Conector tira-tira Imagine
Imagine strip-strip connector
Connecteur bande-bande Imagine
Conector tira-tira Imagine

	⊙	↕
473071	IP20	10mm
473064	IP65	10mm



Conector tira-cable Imagine Proflex
Imagine Proflex strip-cable connector
Connecteur bande-câble Imagine Proflex
Conector tira-cabo Imagine Proflex

	⊙	↕
N 638333	IP20	10mm



Conector tira-tira Imagine Proflex
Imagine Proflex strip-strip connector
Connecteur bande-bande Imagine Proflex
Conector tira-tira Imagine Proflex

	⊙	↕
N 638326	IP20	10mm



LE OUE E T A BOLA



Downlights



Kentau Avant CL



N
NEW



Hasta 5 años garantía ver condiciones
Up to 5 years warranty see conditions
Jusqu'à 5 ans de garantie voir conditions
Até 5 anos de garantia ver condições

Soluciones
Solutions
Des solutions
Soluções

Pack BLUETOOTH



Necesita driver DALI
You need DALI driver
Vous avez besoin d'un driver DALI
Você precisa da driver DALI



N/ Fácil instalación. Tecnología CELLTECH. Driver extraíble e intercambiable Diseño compacto. Montaje versátil, empotrable o superficie. Diseño sencillo, puro, elegante.

E/ Easy installation. CELLTECH technology. Removable and interchangeable driver. Compact design. Versatile mounting, recessed or surface. Simple, pure, elegant design.

F/ Installation facile. Technologie CELLTECH. Amovible du pilote et interchangeable Design compact. Polyvalent, dans la construction ou l'assemblage de surface. Pure, design simple et élégant.

P/ Fácil instalação. Tecnologia CELLTECH. Driver removível e intercambiável. Desenho compacto. Montagem versátil, encastrada ou saliente. Desenho simples, puro, elegante.



	Hz								
220-240V ac	50-60Hz	CII	IP20	IP44	-20°C~+40 °C	100°	(L70B50>) 50.000h	PC-O	AL

BAJO PEDIDO / ON REQUEST / SUR COMMANDE / A PEDIDO



Kit de emergencia 2h (Excepto superficie)

Emergency kit 2h (Except for surface)
Batterie de secours 2h (Sauf surface)
Kit de emergência 2h (Exceto superfície)

[GRÁFICOS: Unidades en mm/ GRÁFICOS: Units in mm/ GRAPHIQUES: Unités en mm/ GRÁFICOS: Unidades em mm]

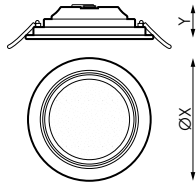

	W _T		φ		K					
*628945	20W	>80	2.174lm	3	3.000K	Gr	RAL 9006	Ø225x50mm	Ø200-205mm	
*634229	20W	>80	2.400lm	4	4.000K	Gr	RAL 9006	Ø225x50mm	Ø200-205mm	
*629355	20W	>80	2.174lm	3	3.000K	Bl	Blanco	Ø225x50mm	Ø200-205mm	
629362	20W	>80	2.400lm	4	4.000K	Bl	Blanco	Ø225x50mm	Ø200-205mm	
*629218	14W	>80	1.490lm	3	3.000K	Gr	RAL 9006	Ø175x50mm	Ø150-155mm	
*629263	14W	>80	1.680lm	4	4.000K	Gr	RAL 9006	Ø175x50mm	Ø150-155mm	
*628884	14W	>80	1.490lm	3	3.000K	Bl	Blanco	Ø175x50mm	Ø150-155mm	
*628815	14W	>80	1.680lm	4	4.000K	Bl	Blanco	Ø175x50mm	Ø150-155mm	
*629164	9W	>80	900lm	3	3.000K	Gr	RAL 9006	Ø150x50mm	Ø130-135mm	
*629232	9W	>80	950lm	4	4.000K	Gr	RAL 9006	Ø150x50mm	Ø130-135mm	
*629287	9W	>80	900lm	3	3.000K	Bl	Blanco	Ø150x50mm	Ø130-135mm	
*629324	9W	>80	950lm	4	4.000K	Bl	Blanco	Ø150x50mm	Ø130-135mm	
*629072	6W	>80	660lm	3	3.000K	Gr	RAL 9006	Ø125x50mm	Ø105-110mm	
*629294	6W	>80	563lm	4	4.000K	Gr	RAL 9006	Ø125x50mm	Ø105-110mm	
*628877	6W	>80	563lm	3	3.000K	Bl	Blanco	Ø125x50mm	Ø105-110mm	
*628785	6W	>80	660lm	4	4.000K	Bl	Blanco	Ø125x50mm	Ø105-110mm	

ACCESORIOS / ACCESSOIRES / ACCESSORIES / ACESSÓRIOS

+ INFO PAG. 44



	W _T		
*629041	9W	Bl	Blanco
*629089	9W	Gr	RAL 9006
*628846	14W	Bl	Blanco
*619188	14W	Gr	RAL 9006
*629348	20W	Bl	Blanco
*629133	20W	Gr	RAL 9006

	W _T	
*600811	6-9W	
*600828	14-20W	
*632140	6W	NO
*632157	9W	NO
*632164	14W	NO
*628822	20W	NO

*Consultar disponibilidad/ *Check availability/ *Vérifier la disponibilité/ *Verificar disponibilidad

Kentau Avant SQ



N
NEW



Hasta 5 años garantía ver condiciones
Up to 5 years warranty see conditions
Jusqu'à 5 ans de garantie voir conditions
Até 5 anos de garantia ver condições

Soluciones
Solutions
Des solutions
Soluções

Pack BLUETOOTH



Necesita driver DALI
You need DALI driver
Vous avez besoin d'un driver DALI
Você precisa da driver DALI



N/ Fácil instalación. Tecnología CELLTECH. Driver extraíble e intercambiable Diseño compacto. Montaje versátil, empotrable o superficie. Diseño sencillo, puro, elegante.

E/ Easy installation. CELLTECH technology. Removable and interchangeable driver. Compact design. Versatile mounting, recessed or surface. Simple, pure, elegant design.

F/ Installation facile. Technologie CELLTECH. Amovible du pilote et interchangeable Design compact. Polyvalent, dans la construction ou l'assemblage de surface. Pure, design simple et élégant.

P/ Fácil instalação. Tecnologia CELLTECH. Driver removível e intercambiável. Desenho compacto. Montagem versátil, encastrada ou saliente. Desenho simples, puro, elegante.



	Hz									
220-240V ac	50-60Hz	CII	IP20	IP44	-20°C~+40 °C	100°	>80	(L70B50>) 50.000h	PC-O	AL

BAJO PEDIDO / ON REQUEST / SUR COMMANDE / A PEDIDO



Kit de emergencia 2h (Excepto superficie)

Emergency kit 2h (Except for surface)
Batterie de secours 2h (Sauf surface)
Kit de emergência 2h (Exceto superfície)

[GRÁFICOS: Unidades en mm/GRAPHICS: Units in mm/GRÁFICOS: Unités en mm/GRÁFICOS: Unidades em mm]

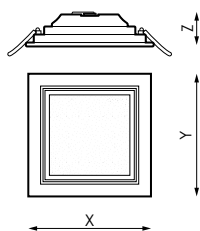

	W _T	φ	K				
*629270	20W	2.140lm	3	3.000K	Gr	RAL 9006	225 x 225 x 30mm
*629256	20W	2.303lm	4	4.000K	Gr	RAL 9006	225 x 225 x 30mm
*628808	20W	2.140lm	3	3.000K	Bl	Blanco	225 x 225 x 30mm
*628952	20W	2.303lm	4	4.000K	Bl	Blanco	225 x 225 x 30mm
*629119	14W	1.471lm	3	3.000K	Gr	RAL 9006	175 x 175 x 30mm
*629201	14W	1.537lm	4	4.000K	Gr	RAL 9006	175 x 175 x 30mm
*629225	14W	1.471lm	3	3.000K	Bl	Blanco	175 x 175 x 30mm
*628860	14W	1.537lm	4	4.000K	Bl	Blanco	175 x 175 x 30mm
*629195	9W	967lm	3	3.000K	Gr	RAL 9006	150 x 150 x 30mm
*629157	9W	1.012lm	4	4.000K	Gr	RAL 9006	150 x 150 x 30mm
*634243	9W	967lm	3	3.000K	Bl	Blanco	150 x 150 x 30mm
*628792	9W	1.012lm	4	4.000K	Bl	Blanco	150 x 150 x 30mm
*628990	6W	587lm	3	3.000K	Gr	RAL 9006	125 x 125 x 30mm
*629027	6W	613lm	4	4.000K	Gr	RAL 9006	125 x 125 x 30mm
*629096	6W	587lm	3	3.000K	Bl	Blanco	125 x 125 x 30mm
*629317	6W	613lm	4	4.000K	Bl	Blanco	125 x 125 x 30mm

ACCESORIOS / ACCESSOIRES / ACCESSORIES / ACESSÓRIOS

+ INFO PAG. 44



	W _T		
*629003	9W	Bl	Blanco
*629102	9W	Gr	RAL 9006
*629010	14W	Bl	Blanco
*629034	14W	Gr	RAL 9006
*629249	20W	Bl	Blanco
*629140	20W	Gr	RAL 9006

	W _T	
*600811	6-9W	
*600828	14-20W	
*632140	6W	NO
*632157	9W	NO
*632164	14W	NO
*628822	20W	NO

*Consultar disponibilidad/ *Check availability/ *Vérifier la disponibilité/ *Verificar disponibilidade

Breno CL

Soluciones
Solutions
Des solutions
Soluções

Pack BLUETOOTH

Pack CTE

Pack Aulas









 Necesita driver DALI
You need DALI driver
Vous avez besoin d'un driver DALI
Você precisa da driver DALI



Breno CL

Ñ/ Módulo PCB fabricado en aluminio para favorecer la disipación de temperatura. Placa de policarbonato interna para mejorar la reflexión lumínica. Luz perimetral. **E/** PCB Module of aluminum to facilitate temperature dissipation. Internal polycarbonate board to improve the light reflection. Perimetral light. **F/** Module PCB réalisée en aluminium afin de faire facilement la dissipation de température. Plaque interne de polycarbonate pour améliorer le reflect de la lumière. Lumière périmétrique. **P/** Módulo PCB feito em alumínio, a fim de facilitar a dissipação de temperatura. Placa interna de policarbonato para melhorar o reflexo da luz. Luz perimetral.



								
220-240V ac	50-60Hz	CII	IP20	120°	>80	(L70B50>) 35.000h	PS	AL

[GRÁFICOS: Unidades en mm/ GRAPHICS: Units in mm/ GRÁFICOS: Unidades em mm]

Breno CL

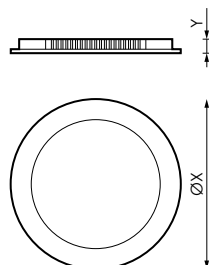

	W_T	ϕ_T	K	\odot	\leftrightarrow	
482820	6W	338lm	3 3.000K	Bl	Blanco	Ø90 x 18mm Ø75mm
482837	6W	359lm	4 4.000K	Bl	Blanco	Ø90 x 18mm Ø75mm
*N 643320	6W	409lm	6.5 6.500K	Bl	Blanco	Ø90 x 18mm Ø75mm
482844	6W	338lm	3 3.000K	Gr	RAL 9006	Ø90 x 18mm Ø75mm
482851	6W	359lm	4 4.000K	Gr	RAL 9006	Ø90 x 18mm Ø75mm
482868	9W	511lm	3 3.000K	Bl	Blanco	Ø120 x 18mm Ø105mm
482875	9W	544lm	4 4.000K	Bl	Blanco	Ø120 x 18mm Ø105mm
*N 643313	9W	598lm	6.5 6.500K	Bl	Blanco	Ø120 x 18mm Ø105mm
482882	9W	511lm	3 3.000K	Gr	RAL 9006	Ø120 x 18mm Ø105mm
482899	9W	544lm	4 4.000K	Gr	RAL 9006	Ø120 x 18mm Ø105mm
482905	12W	929lm	3 3.000K	Bl	Blanco	Ø170 x 18mm Ø160mm
482912	12W	984lm	4 4.000K	Bl	Blanco	Ø170 x 18mm Ø160mm
*N 643306	12W	1.034lm	6.5 6.500K	Bl	Blanco	Ø170 x 18mm Ø160mm
482929	12W	929lm	3 3.000K	Gr	RAL 9006	Ø170 x 18mm Ø160mm
482936	12W	984lm	4 4.000K	Gr	RAL 9006	Ø170 x 18mm Ø160mm
482943	18W	1.385lm	3 3.000K	Bl	Blanco	Ø225 x 18mm Ø205mm
482950	18W	1.458lm	4 4.000K	Bl	Blanco	Ø225 x 18mm Ø205mm
482967	18W	1.535lm	6.5 6.500K	Bl	Blanco	Ø225 x 18mm Ø205mm
482974	18W	1.385lm	3 3.000K	Gr	RAL 9006	Ø225 x 18mm Ø205mm
482981	18W	1.458lm	4 4.000K	Gr	RAL 9006	Ø225 x 18mm Ø205mm

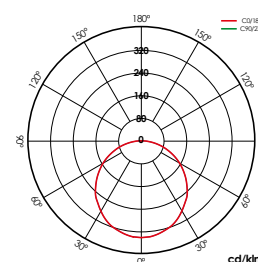

18W/3.000K

BAJO PEDIDO / ON REQUEST / SUR COMMANDE / A PEDIDO



Kit de emergencia 1h

Emergency kit 1h

Batterie de secours 1h

Kit de emergência 1h

*Consultar disponibilidad/ *Check availability/ **Vérifier la disponibilité/ **Verificar disponibilidade

Accesorios

Accessories

Accessoires

Acessórios

Icon	Part Number	Kentau Avant CL				Kentau Avant SQ			
		6W	9W	14W	20W	6W	9W	14W	20W
⏏	600811	•	•			•	•		
	600828			•	•			•	•
	632140	•				•			
	632157		•				•		
	632164			•				•	
	628822				•				•
↑	629041		•						
	629089		•						
	628846			•					
	619188			•					
	629348				•				
	629133				•				
	629003						•		
	629102						•		
	629010							•	
	629034							•	
	629249								•
	629140								•
	590563								
	590570								
	590587								



Driver con regulación
Driver with dimming
Driver avec régulation
Driver com regulamento

Icon	W _T	Icon
*507325	20W	
*507332	14W	
*532181	20W	1-10V
*532198	14W	1-10V
*532204	9W	1-10V
*532211	6W	1-10V





Accesorio superficie
Accessory surface
Cadre Saillie
Superfície acessória

Icon	W _T	Icon	Color
*629041	9W		Blanco
*629089	9W		RAL 9006
*628846	14W		Blanco
*619188	14W		RAL 9006
*629348	20W		Blanco
*629133	20W		RAL 9006

*Consultar disponibilidad/ *Check availability/ **Vérifier la disponibilité/ **Verificar disponibilidad







Accesorio superficie
Accessory surface
Cadre Saillie
Superfície accessória

	W _T		
*629003	9W	Bl	Blanco
*629102	9W	Gr	RAL 9006
*629010	14W	Bl	Blanco
*629034	14W	Gr	RAL 9006
*629249	20W	Bl	Blanco
*629140	20W	Gr	RAL 9006



Driver
Driver
Driver
Driver

	W _T	
*600811	6-9W	
*600828	14-20W	
*632140	6W	NO
*632157	9W	NO
*632164	14W	NO
*628822	20W	NO



[GRÁFICOS: Unidades en mm/ GRAPHICS: Units in mm/GRÁFICOS: Unidades en mm/ GRÁFICOS: Unidades en mm]

IES Serpis
Valencia

*Consultar disponibilidad/ *Check availability/ *Vérifier la disponibilité/ *Verificar disponibilidad



Solar
Solar
Solaire
Solar



Vorona Switch

N
NEW



Con selector de tº de color a través de interruptor
With tº color selector through switch
Avec sélecteur tº de couleur par commutateur
Com o seletor de cores através da chave



Sensor de Luminosidad
Brightness Sensor
Capteur de Lumière
Sensor de luz



Solar
Solar
Solaire
Solar

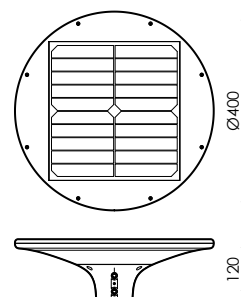

Barcode	W _T	φ _T	K	Color
*640947	20W	2.407lm 2.511lm	3 3.000K 4 4.000K	N RAL 9005

CIII	IP65	>80	(L70B50>) 35.000h	PC	ABS

INFORMACIÓN / INFORMATION / INFORMATION / INFORMAÇÕES



Ñ/ Batería reemplazable

F/ Batterie remplaçable

E/ Replaceable battery

P/ Bateria substituível

*Consultar disponibilidad/ *Check availability/ **Vérifier la disponibilité/ **Verificar disponibilidade





Green

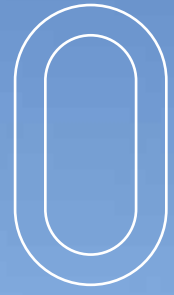

Arette

Avant



6W



12W

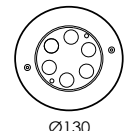

Ø130

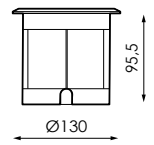

95.5

Ø130

6W

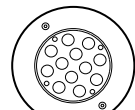

Ø180

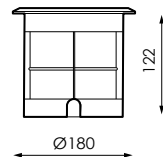

122

Ø180

12W

	W _{LED}	W _T	φ	φ _{LED}	φ _T	K	
N 652384	5W	6W	>0,9	686 lm	567lm	3	3.000K 6
483605	5W	6W	>0,9	702lm	583lm	4	4.000K 6
N 652391	10,5W	12W	>0,9	1.435 lm	1.211lm	3	3.000K 12
483612	10,5W	12W	>0,9	1.496lm	1.230lm	4	4.000K 12

	Hz									
100-240V ac	50-60Hz	CI	IP67	K08 (12W) IK09 (6W)	(L70B50>) 50.000h	>70	2.000kg	PVC	FE INOX	EMPOTRABLE

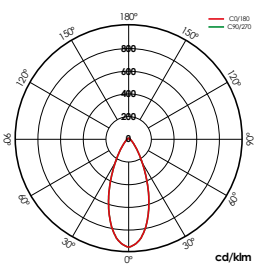

6W

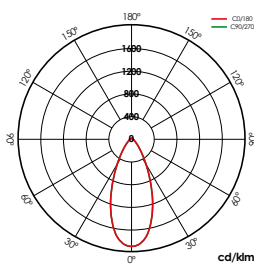

12W

*Consultar disponibilidad/ *Check availability/ **Vérifier la disponibilité/ **Verificar disponibilidad





AJUNTA

CARPINTERIA DE ALUM

CERRAJERIA - MUEBLES - PORMENOS A DITOS - BARRERAS

T. 681 673 304

CARPINTERIA DE ALUM

CERRAJERIA - MUEBLES - PORMENOS A DITOS - BARRERAS

T. 681 673 304

Proyectores

Projectors
Projecteurs
Projetores



Chio Avant

DALI

N
NEW







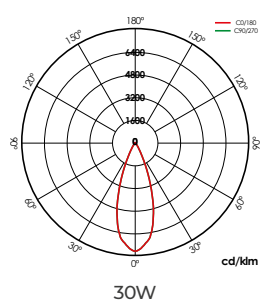

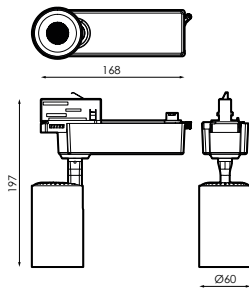
N/ Carril electrificado trifásico y accesorios en blanco, negro y gris. Adaptador para carril trifásico 250V 6A. **E/** Three-phase electrified rail and accessories in white, black and grey. Adapter for three phase track 250V 6A. **F/** Rail électrique triphasé et accessoires en blanc, noir et gris. Adaptateur pour le montage à trois phases voies 250V 6A. **P/** Calha electrificada trifásica e acessórios em branco, preto e cinza. Alimentador para calha trifásica 250V 6A.



	Hz	ϕ			Δ		
220-240V ac	50-60Hz	> 0,9	CII	IP20	36°	>90	(L70B50>) 30.000h





	W _{LED}	W _T	φ _{LED}	φ _T	K				
627856	27W	30W	3.645lm	3.059lm	3	3.000K	BI	Blanco	
627863	27W	30W	3.727lm	3.128lm	4	4.000K	BI	Blanco	
627887	27W	30W	3.645lm	3.059lm	3	3.000K	N	Negro	
627894	27W	30W	3.727lm	3.128lm	4	4.000K	N	Negro	

ACCESORIOS / ACCESSOIRES / ACCESSORIES / ACESSÓRIOS

+ INFO PAG.34



484572

Lente 24° 30W



484626

Accesorio 30W blanco oval
snoot



484633

Accesorio 30W negro oval
snoot

Akagy Switch

N
NEW



Hasta 5 años garantía ver condiciones
Up to 5 years warranty see conditions
Jusqu'à 5 ans de garantie voir conditions
Até 5 anos de garantia ver condições



Con selector de tª de color a través de interruptor
With tª color selector through switch
Avec sélecteur tª de couleur par commutateur
Com o seletor de cores através da chave



Con selector de potencia a través de interruptor
With power selector switch
Avec sélecteur de puissance
Com interruptor de seleção de potência





Protector Sobretensiones
Surge Protector
Parasurtenseur
Protetor Contra Surtos



	Hz		φ								
120-240V ac	50-60Hz	Clase I	$\geq 0,9$	IP65	IK08	>70	L70>50.000h	-5°C~+35°C	90°	VT-T	AL



		W_{LED}		ϕ_{LED}	ϕ_T	K			
				3.300lm	2.800lm	3	3.000K		
		20W	270mA	3.400lm	2.900lm	4	4.000K		
				3.500lm	3.000lm	5	5.000K		
				5.000lm	4.500lm	3	3.000K		
*638937		30W	270mA	4.900lm	4.400lm	4	4.000K	Gr	Gris RAL 9007 200x288x53mm 4kV/6kV
				4.800lm	4.300lm	5	5.000K		
				7.800lm	7.300lm	3	3.000K		
		50W	270mA	7.900lm	7.400lm	4	4.000K		
				8.000lm	7.500lm	5	5.000K		
				7.400lm	7.300lm	3	3.000K		
		50W	540mA	7.500lm	7.400lm	4	4.000K		
				7.600lm	7.500lm	5	5.000K		
				11.900lm	11.800lm	3	3.000K		
*638944		80W	540mA	12.000lm	11.900lm	4	4.000K	Gr	Gris RAL 9007 274x346x53 mm 4kV/6kV
				12.100lm	12.000lm	5	5.000K		
				15.800lm	14.800lm	3	3.000K		
		100W	540mA	15.900lm	14.900lm	4	4.000K		
				16.000lm	15.000lm	5	5.000K		
				15.800lm	14.800lm	3	3.000K		
		100W	1100mA	15.900lm	14.900lm	4	4.000K		
				16.000lm	15.000lm	5	5.000K		
				23.300lm	22.300lm	3	3.000K		
*638951		150W	1100mA	23.400lm	22.400lm	4	4.000K	Gr	Gris RAL 9007 363x419x56 mm 6kV/6kV
				23.500lm	22.500lm	3	3.000K		
				30.800lm	29.800lm	3	3.000K		
		200W	1100mA	30.900lm	29.900lm	4	4.000K		
				31.000lm	30.000lm	5	5.000K		
				25.300lm	22.300lm	3	3.000K		
		150W	1.600mA	24.400lm	22.400lm	4	4.000K		
				25.500lm	22.500lm	5	5.000K		
				32.800lm	29.800lm	3	3.000K		
*638968		200W	1.600mA	32.900lm	29.00lm	4	4.000K	Gr	Gris RAL 9007 420x488x57mm 6kV/6kV
				33.000lm	30.000lm	5	5.000K		
				47.800lm	44.800lm	3	3.000K		
		300W	1.600mA	47.900lm	44.900lm	4	4.000K		
				48.000lm	45.000lm	5	5.000K		

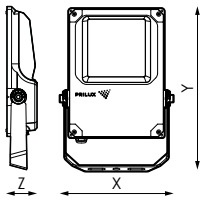

[GRÁFICOS: Unidades en mm/ GRÁFICOS: Units in mm/ GRÁFICOS: Unités en mm/ GRÁFICOS: Unidades em mm]

*Consultar disponibilidad/ *Check availability/ **Vérifier la disponibilité/ **Verificar disponibilidad

Akagy Basic

N
NEW



Hasta 5 años garantía ver condiciones
Up to 5 years warranty see conditions
Jusqu'à 5 ans de garantie voir conditions
Até 5 anos de garantia ver condições



Protector Sobretensiones
Surge Protector
Parasurtenseur
Protetor Contra Surtos



	W_{LED}		ϕ_{LED}	ϕ_T	K	
*638920	50W	270mA	7.800lm	7.300lm	3	3.000K 4KV/6KV
*638913	50W	270mA	7.900lm	7.400lm	4	4.000K 4KV/6KV
*638906	50W	270mA	8.000lm	7.500lm	5	5.000K 4KV/6KV

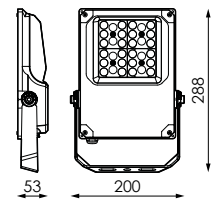

	Hz		ϕ								
120-240V ac	50-60Hz	Clase I	$\geq 0,9$	IP65	IK08	>70	L70>50.000h	-5°C~+35°C	120°	VT-T	AL

*Consultar disponibilidad/ *Check availability/ **Vérifier la disponibilité/ **Verificar disponibilidad



Kenia



Protector Sobretensiones
Surge Protector
Parasurtenseur
Protector Contra Surtos



	Hz						
230V ac	50-60Hz	Clase I	IP65	>80	(L70B50>) 25.000h	VT-O	AL



*Consultar disponibilidad/ *Check availability/ *Vérifier la disponibilité/ *Verificar disponibilidad

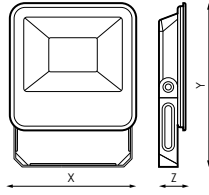

	W _{LED}	Φ _r	Φ	K	Δ	⊗	↕	↕	⚡	
504638	10W	911lm	>0,5	3	3.000K	100°	Gr	RAL7045	109 x 90 x 27mm	1KV/2KV
504645	10W	987lm	>0,5	5	5.000K	100°	Gr	RAL7045	109 x 90 x 27mm	1KV/2KV
504652	20W	1.823lm	>0,5	3	3.000K	100°	Gr	RAL7045	165 x 135 x 30mm	2KV/2KV
*N 647885	20W	1.883lm	>0,5	4	4.000K	100°	Gr	RAL7045	165 x 135 x 30mm	1KV/2KV
504669	20W	1.923lm	>0,5	5	5.000K	100°	Gr	RAL7045	165 x 135 x 30mm	2KV/2KV
504676	30W	2.618lm	>0,9	3	3.000K	110°	Gr	RAL7045	186 x 135 x 30mm	2KV/2KV
*N 647892	30W	2.692lm	>0,9	4	4.000K	110°	Gr	RAL7045	186 x 135 x 30mm	2KV/2KV
504683	30W	2.743lm	>0,9	5	5.000K	110°	Gr	RAL7045	186 x 135 x 30mm	2KV/2KV
*N 647939	30W	2.692lm	>0,9	4	4.000K	110°	Bl	Blanco	186 x 135 x 30mm	2KV/2KV
522533	30W	2.743lm	>0,9	5	5.000K	110°	Bl	Blanco	186 x 135 x 30mm	2KV/2KV
504690	50W	4.371lm	>0,9	3	3.000K	110°	Gr	RAL7045	240 x 180 x 30mm	2KV/2KV
*N 647908	50W	4.438lm	>0,9	4	4.000K	110°	Gr	RAL7045	240 x 180 x 30mm	2KV/2KV
504706	50W	4.516lm	>0,9	5	5.000K	110°	Gr	RAL7045	240 x 180 x 30mm	2KV/2KV
*N 647946	50W	4.438lm	>0,9	4	4.000K	110°	Bl	Blanco	240 x 180 x 30mm	2KV/2KV
522540	50W	4.516lm	>0,9	5	5.000K	110°	Bl	Blanco	240 x 180 x 30mm	2KV/2KV
504713	70W	6.203lm	>0,9	3	3.000K	110°	Gr	RAL7045	287 x 243 x 37mm	1KV/2KV
*N 647915	70W	6.267lm	>0,9	4	4.000K	110°	Gr	RAL7045	287 x 243 x 37mm	1KV/2KV
504720	70W	6.318lm	>0,9	5	5.000K	110°	Gr	RAL7045	287 x 243 x 37mm	1KV/2KV
504737	100W	8.711lm	>0,9	3	3.000K	110°	Gr	RAL7045	313 x 243 x 37mm	2KV/2KV
*N 647922	100W	8.813lm	>0,9	4	4.000K	110°	Gr	RAL7045	313 x 243 x 37mm	2KV/2KV
504744	100W	8.839lm	>0,9	5	5.000K	110°	Gr	RAL7045	313 x 243 x 37mm	2KV/2KV
*N 647953	150W	21.000lm	>0,9	3	3.000K	110°	Gr	RAL7045	335x274x46mm	2KV/2KV
*N 647960	150W	21.058lm	>0,9	4	4.000K	110°	Gr	RAL7045	335x274x46mm	2KV/2KV
*N 647977	150W	21.115lm	>0,9	5	5.000K	110°	Gr	RAL7045	335x274x46mm	2KV/2KV
*N 647984	200W	28.000lm	>0,9	3	3.000K	110°	Gr	RAL7045	390x306x56mm	2KV/2KV
*N 647991	200W	28.058lm	>0,9	4	4.000K	110°	Gr	RAL7045	390x306x56mm	2KV/2KV
*N 648004	200W	28.115lm	>0,9	5	5.000K	110°	Gr	RAL7045	390x306x56mm	2KV/2KV

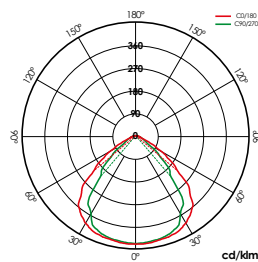

10W

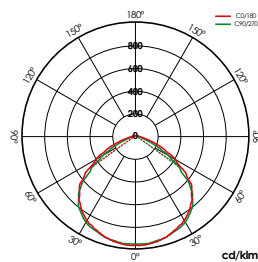

30W

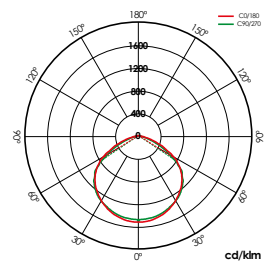

50W







*Consultar disponibilidad/ *Check availability/ *Vérifier la disponibilité/ *Verificar disponibilidad

Accesorios

Accessories

Accessoires

Acessórios

		Chio Avant DALI		
		626217	•	
		630276	•	
		235006	•	
			376679	•
			235983	•
			623988	•
			621229	•
		623995	•	
		630313	•	
		624343	•	
		379359	•	
		630306	•	
		630290	•	
		624336	•	
		621205	•	
		624008	•	
		629515	•	
		630283	•	
		621212	•	
		624015	•	
		378345	•	
		383011	•	
		484572	•	
		484626	•	
		484633	•	



484572

Lente Chio 24° 30W
Chio Lens 24° 30W
Objectif Chio 24° 30W
Lente Chio 24° 30W



484626

Accesorio chio 30W blanco oval
snoot
Accessory chio 30W white oval
snoot
Accessoire chio 30W blanc ovale
snoot
Acessório chio 30W branco oval
snoot oval



484633

Accesorio chio 30W negro oval
snoot
Accessory chio 30W black oval
snoot
Accessoire chio 30W snoot ovale
noir
Acessório chio 30W preto oval snoot
oval

626217	Carril electrificado 3F+N+TT 16A/ Electrified rail 3F+N+TT 16A/ Rail électrifié 3F+N+TT 16A/ Calha eletrificada 3F+N+TT 16A	BI	Blanco	1.000 x 31,5 x 32,5mm
630276	Carril electrificado 3F+N+TT 16A/ Electrified rail 3F+N+TT 16A/ Rail électrifié 3F+N+TT 16A/ Calha eletrificada 3F+N+TT 16A	N	Negro	1.000 x 31,5 x 32,5mm
235006	Carril electrificado 3F+N+TT 16A/ Electrified rail 3F+N+TT 16A/ Rail électrifié 3F+N+TT 16A/ Calha eletrificada 3F+N+TT 16A	BI	Blanco	2.000 x 31,5 x 32,5mm
376679	Carril electrificado 3F+N+TT 16A/ Electrified rail 3F+N+TT 16A/ Rail électrifié 3F+N+TT 16A/ Calha eletrificada 3F+N+TT 16A	N	Negro	2.000 x 31,5 x 32,5mm
235983	Carril electrificado 3F+N+TT 16A/ Electrified rail 3F+N+TT 16A/ Rail électrifié 3F+N+TT 16A/ Calha eletrificada 3F+N+TT 16A	BI	Blanco	3.000 x 31,5 x 32,5mm
623988	Carril electrificado 3F+N+TT 16A/ Electrified rail 3F+N+TT 16A/ Rail électrifié 3F+N+TT 16A/ Calha eletrificada 3F+N+TT 16A	N	Negro	3.000 x 31,5 x 32,5mm
630313	Kit suspensión/ Suspension Kit/ Kit de suspension/ Kit de suspensão	BI	Blanco	3.000mm
624343	Kit suspensión/ Suspension Kit/ Kit de suspension/ Kit de suspensão	N	Negro	3.000mm
379359	Kit suspensión/ Suspension Kit/ Kit de suspension/ Kit de suspensão	BI	Blanco	1.500mm
630306	Kit suspensión/ Suspension Kit/ Kit de suspension/ Kit de suspensão	N	Negro	1.500mm
621229	Alimentador eléctrico lateral/ Lateral power feeder/ Alimentateur latéral électrique/ Alimentador lateral elétrico	BI	Blanco	-
623995	Alimentador eléctrico lateral/ Lateral power feeder/ Alimentateur latéral électrique/ Alimentador lateral elétrico	N	Negro	-
630290	Conector lineal externo/ External linear connector/ Connecteur linéaire externe/ Conector linear externo	BI	Blanco	-
624336	Conector lineal externo/ External linear connector/ Connecteur linéaire externe/ Conector linear externo	N	Negro	-
621205	Conector lineal interno/ Internal linear connector/ Connecteur linéaire interne/ Conector linear interno	BI	Blanco	-
624008	Conector lineal interno/ Internal linear connector/ Connecteur linéaire interne/ Conector linear interno	N	Negro	-
629515	Conector exterior en L/ External linear connector in L shape/ Connecteur externe en L/ Conector L externo	BI	Blanco	-
630283	Conector exterior en L/ External linear connector in L shape/ Connecteur externe en L/ Conector L externo	N	Negro	-
621212	Tapa final/ End cap/ Couvercle d'extrémité/ Tampa da extremidade	BI	Blanco	-
624015	Tapa final/ End cap/ Couvercle d'extrémité/ Tampa da extremidade	N	Negro	-
378345	Adaptador superficie/ Surface adapter/ Adaptateur de surface/ Adaptador de superficie	BI	Blanco	-
383011	Adaptador superficie/ Surface adapter/ Adaptateur de surface/ Adaptador de superficie	N	Negro	-

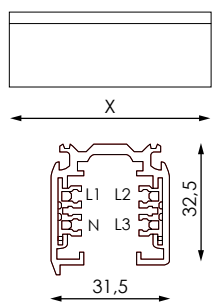

N 626217/630276/235006/376679/235983

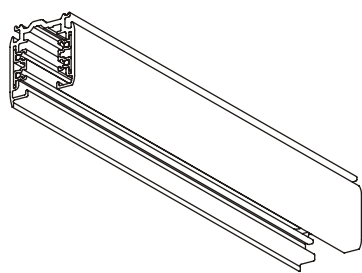

N 630313/624343/379359/630306

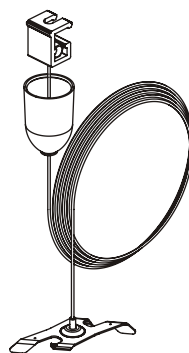

N 621229/623995

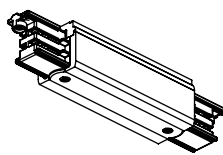
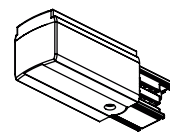

N 630290/624336

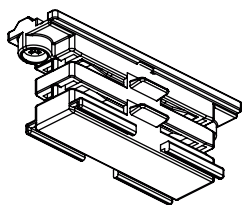

N 621205/624008

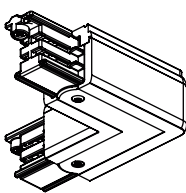

N 629515/630283

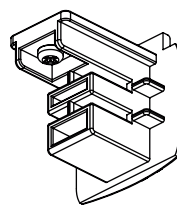

N 621212/624015

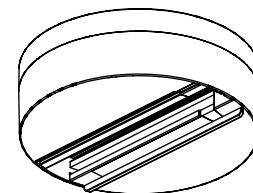

N 378345/383011



Industrial
Industrial
Industrial
Industrial



Ákora HE

N
NEW



Hasta 5 años garantía ver condiciones
Up to 5 years warranty see conditions
Jusqu'à 5 ans de garantie voir conditions
Até 5 anos de garantia ver condições

Soluciones
Solutions
Des solutions
Soluções

Cora Industry Lite

Pack BLUETOOTH



Ñ/ El montaje del reflector conlleva una reducción del flujo del 4%. Este producto se sirve con 2 mangueras incorporadas de 250mm.

E/ The installation of the reflector leads to a 4% reduction in flow. This product comes with 2 x 250mm hoses.

F/ Le montage du réflecteur entraîne une réduction du débit de 4 %. Ce produit est fourni avec 2 tuyaux de 250 mm.



P/ A montagem do refletor conduz a uma redução do caudal de 4%. Este produto é fornecido com 2 mangueiras de 250 mm.

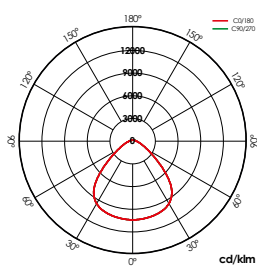

	Hz	ϕ				>80 icon"/>						
100-240V ac	50-60Hz	0,9	CI	IP65	IK10	>80	-30°C~+50 °C	90°	(L70B50>) 50.000h	Negro	PC	AL DALI

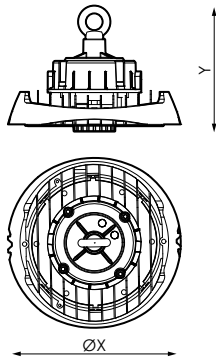



	W_{LED}	W_T		ϕ_{LED}	ϕ_T	K	
*629720	92W	100W	600mA	16.995lm	16.500lm	5	5.000K Ø240 x 165mm
*629737	92W	100W	600mA	16.995lm	16.500lm	4	4.000K Ø240 x 165mm
*629744	138W	150W	750mA	25.493lm	24.750lm	5	5.000K Ø280 x 165mm
*629751	138W	150W	750mA	25.493lm	24.750lm	4	4.000K Ø280 x 165mm
*629768	186W	200W	1.000mA	33.990lm	33.000lm	5	5.000K Ø320 x 165mm
*629775	186W	200W	1.000mA	33.990lm	33.000lm	4	4.000K Ø320 x 165mm

ACCESORIOS / ACCESSOIRES / ACCESSORIES / ACESSÓRIOS

+ INFO PAG.52



629911

Kit lira 100W



629928

Kit lira 150W



629935

Kit lira 200W



629881

Rejilla protectora 100W



629898

Rejilla protectora 150W



629904

Rejilla protectora 200W



629782

Reflector AL 100W 60°



629812

Reflector AL 100W 90°



629799

Reflector AL 150W 60°



629829

Reflector AL 150W 90°



629805

Reflector AL 200W 60°



629836

Reflector AL 200W 90°

*Consultar disponibilidad/ *Check availability/ *Vérifier la disponibilité/ *Verificar disponibilidade

Ákora Switch

N
NEW



Hasta 5 años garantía ver condiciones
Up to 5 years warranty see conditions
Jusqu'à 5 ans de garantie voir conditions
Até 5 anos de garantia ver condições



Con selector de tª de color a través de interruptor
With tª color selector through switch
Avec sélecteur tª de couleur par commutateur
Com o seletor de cores através da chave



Con selector de potencia a través de interruptor
With power selector switch
Avec sélecteur de puissance
Com interruptor de seleção de potência

N/ El montaje del reflector conlleva una reducción del flujo del 4%. Este producto se sirve con 2 mangueras incorporadas de 250mm.

E/ The installation of the reflector leads to a 4% reduction in flow. This product comes with 2 x 250mm hoses.

F/ Le montage du réflecteur entraîne une réduction du débit de 4%. Ce produit est fourni avec 2 tuyaux de 250 mm.

P/ A montagem do refletor conduz a uma redução do caudal de 4%. Este produto é fornecido com 2 mangueiras de 250 mm.



						>80 icon"/>							
100-240V ac	50-60Hz	0,9	CI	IP65	IK10	>80	-30°C~+50 °C	90°	(L70B50>) 50.000h	Negro	PC	AL	1-10V

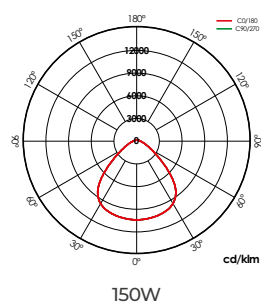

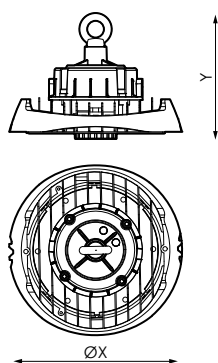

	W_{LED}	W_T		ϕ_{LED}	ϕ_T	K	
629690	54W	60W	400mA	8.652lm	8.400lm	4	4.000K
						4,5	4.500K
						5	5.000K
						4	4.000K
						4,5	4.500K
629706	72W	80W	500mA	11.536lm	11.200lm	5	5.000K
						4	4.000K
						4,5	4.500K
						5	5.000K
						4	4.000K
629713	92W	100W	600mA	14.120lm	14.000lm	4	4.000K
						4,5	4.500K
						5	5.000K
						4	4.000K
						4,5	4.500K
629706	111W	120W	600mA	17.304lm	16.800lm	4	4.000K
						4,5	4.500K
						5	5.000K
						4	4.000K
						4,5	4.500K
629713	138W	150W	750mA	21.630lm	21.000lm	5	5.000K
						4	4.000K
						4,5	4.500K
						5	5.000K
						4	4.000K
629713	138W	150W	850mA	21.230lm	21.000lm	4	4.000K
						4,5	4.500K
						5	5.000K
						4	4.000K
						4,5	4.500K
629713	186W	200W	1.000mA	28.840lm	28.000lm	4,5	4.500K
						5	5.000K

ACCESORIOS / ACCESSOIRES / ACCESSORIES / ACESSÓRIOS

+ INFO PAG. 52



646628

Kit Emergencia Akora
20WLiFePO4 12.8V
6.4Ah 3H



501521

Detector de movimiento.
Válido para grandes
alturas 2/3 niveles 1-10V



507578

Control remoto detector
de movimiento gran
altura



629911

Kit lira 100W



629928

Kit lira 150W



629935

Kit lira 200W



629881

Rejilla protectora 100W



629898

Rejilla protectora 150W



629904

Rejilla protectora 200W



629782

Reflector AL 100W 60°



629812

Reflector AL 100W 90°



629799

Reflector AL 150W 60°



629829

Reflector AL 150W 90°



629805

Reflector AL 200W 60°



629836

Reflector AL 200W 90°

Accesorios

Accessories

Accessoires

Acessórios

		Ákora HE	Ákora Switch
☒	629782	•	•
	629812	•	•
	629799	•	•
	629829	•	•
	629805	•	•
	629836	•	•
	629881	•	•
	629898	•	•
	629904	•	•
⌋	629911	•	•
	629928	•	•
	629935	•	•
🛡️	646628		•
⌋ ☒	501521		•
	507578		•



629782

Reflector Aluminio 100W 60°
Aluminum Reflector 100W 60°
Réflecteur Aluminium 100W 60°
Refletor Alumínio 100W 60°



629812

Reflector Aluminio 100W 90°
Aluminum Reflector 100W 90°
Réflecteur Aluminium 100W 90°
Refletor Alumínio 100W 90°

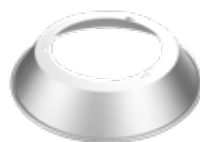

629799

Reflector Aluminio 150W 60°
Aluminum Reflector 150W 60°
Réflecteur Aluminium 150W 60°
Refletor Alumínio 150W 60°



629829

Reflector Aluminio 150W 90°
Aluminum Reflector 150W 90°
Réflecteur Aluminium 150W 90°
Refletor Alumínio 150W 90°



629805

Reflector Aluminio 200W 60°
Aluminum Reflector 200W 60°
Réflecteur Aluminium 200W 60°
Refletor Alumínio 200W 60°



629836

Reflector Aluminio 200W 90°
Aluminum Reflector 200W 90°
Réflecteur Aluminium 200W 90°
Refletor Alumínio 200W 90°



629911

Kit lira 100W
Bracket kit 100W
Kit support 100W
Kit suporte 100W



629928

Kit lira 150W
Bracket kit 150W
Kit support 150W
Kit suporte 150W



629935

Kit lira 200W
Bracket kit 200W
Kit support 200W
Kit suporte 200W



629881

Rejilla seguridad 100W
Protective grid 100W
Grille de sécurité 100W
Grade de segurança 100W



629898

Rejilla seguridad 150W
Protective grid 150W
Grille de sécurité 150W
Grade de segurança 150W



629904

Rejilla seguridad 200W
Protective grid 200W
Grille de sécurité 200W
Grade de segurança 200W



646628

Kit Emergencia Akora 20WLiFePO4
12.8V 6.4Ah 3H
Emergency Kit Akora 20WLiFePO4
12.8V 6.4Ah 3H
Batterie de secours Akora 20WLiFe-
PO4 12.8V 6.4Ah 3H
Kit de emergência Akora 20WLiFe-
PO4 12,8V 6,4Ah 3H



507578

Control remoto para el detector de
movimiento de grandes alturas.
Remote control motion detector for
high ceilings
Télécommande pour détecteur de
mouvement de grande hauteur.
Control remoto para detector de
movimento de arranha-céus.



501521

Detector de movimiento.
Válido para grandes alturas (hasta 15m) 2/3 niveles 1-10V.
Movement detector.
Valid for high altitudes (up to 15m) 2/3 levels 1-10V.
Détecteur de mouvement.
Valable pour les hautes altitudes (jusqu'à 15m) 2/3 niveaux 1-10V.
Detector de movimento.
Válido para altas altitudes (até 15m) 2/3 níveis 1-10V.



alma & balance

Fisioterapia

City



Camíño da Seara - Poio
Pontevedra

Dorna



Barcode	W _T	Φ _{LED}	Φ _T	K	Color	Finish	Protection
*652476	30W	4.500lm	3.800lm	3	3.000K	Gr	Gris RAL 9007 4kV
*650403	30W	4.500lm	3.800lm	4	4.000K	Gr	Gris RAL 9007 4kV
*637374	50W	7.100lm	6.000lm	3	3.000K	Gr	Gris RAL 9007 4kV
636322	50W	7.100lm	6.000lm	4	4.000K	Gr	Gris RAL 9007 4kV
637381	70W	9.900lm	8.400lm	3	3.000K	Gr	Gris RAL 9007 4kV
636339	70W	9.900lm	8.400lm	4	4.000K	Gr	Gris RAL 9007 4kV
*651196	100W	13.800lm	12.550lm	3	3.000K	Gr	Gris RAL 9007 4kV
*651202	100W	13.800lm	12.550lm	4	4.000K	Gr	Gris RAL 9007 4kV

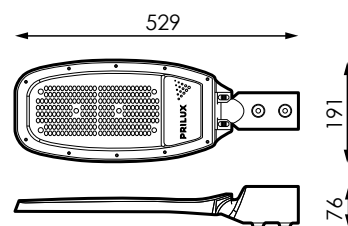

Voltage	Frequency	Beam Angle	Class	IP	Material	Temp Range	Beam Type	Beam Spread	Life	Material	Material
220-240V ac	50-60Hz	> 0,9	Clase I	IP66	08	-20°C~+50°C	Asimétrica Vial	>70	(L70B50->) 50.000h	PC-T	AL iap

*Consultar disponibilidad/ *Check availability/ *Vérifier la disponibilité/ *Verificar disponibilidad

[GRÁFICOS: Unidades en mm/ GRAPHICS: Units in mm/ GRÁFICOS: Unidades en mm/ GRÁFICOS: Unidades en mm]



playtech



City





Nebira

*Nueva luminaria
vial Solar*

Solar



Nebira

N/ Nebira es una luminaria solar compacta diseñada para iluminar calles y carreteras urbanas.

Equipada con paneles solares monocristalinos de hasta 10 años de garantía y baterías con una vida útil de hasta 5 años, ofrece durabilidad y eficiencia energética. Fabricada con materiales robustos como aluminio fundido y vidrio templado, posee certificaciones IK08 e IP66 que aseguran protección contra impactos, polvo y agua, adaptándose a entornos desafiantes.

Ofrece una alta eficiencia lumínica de hasta 200lm/W y una vida útil prolongada, con sensores de presencia y luminosidad que garantizan una iluminación precisa y eficiente, activándose automáticamente según sea necesario para contribuir a la sostenibilidad y la innovación tecnológica.

E/ Nebira is a compact solar luminaire designed to light urban streets and roads.

Equipped with monocrystalline solar panels with up to 10 years warranty and batteries with a life of up to 5 years, it offers durability and energy efficiency. Manufactured with robust materials such as cast aluminium and tempered glass, it holds IK08 and IP66 certifications that ensure protection against impacts, dust and water, adapting to challenging environments.

It offers high luminous efficiency of up to 200lm/W and a long life, with presence and luminosity sensors that guarantee precise and efficient lighting, automatically activating as required to contribute to sustainability and technological innovation.

F/ Nebira est un luminaire solaire compact conçu pour éclairer les rues et les routes urbaines.

Équipé de panneaux solaires monocristallins garantis jusqu'à 10 ans et de batteries d'une durée de vie de 5 ans, il offre durabilité et efficacité énergétique. Fabriqué avec des matériaux robustes tels que la fonte d'aluminium et le verre trempé, il est certifié IK08 et IP66, ce qui garantit une protection contre les chocs, la poussière et l'eau, et lui permet de s'adapter à des environnements difficiles.

Il offre une efficacité lumineuse élevée (jusqu'à 200 lm/W) et une longue durée de vie, avec des capteurs de présence et de luminosité qui garantissent un éclairage précis et efficace, s'activant automatiquement en fonction des besoins pour contribuer à la durabilité et à l'innovation technologique.

P/ A Nebira é uma luminária solar compacta concebida para iluminar ruas e estradas urbanas.

Equipada com painéis solares monocristalinos com garantia de até 10 anos e baterias com vida útil de até 5 anos, oferece durabilidade e eficiência energética. Fabricada com materiais robustos como o alumínio fundido e o vidro temperado, possui certificações IK08 e IP66 que garantem proteção contra impactos, poeiras e água, adaptando-se a ambientes desafiantes.

Oferece alta eficiência luminosa de até 200lm/W e longa vida útil, com sensores de presença e luminosidade que garantem uma iluminação precisa e eficiente, acionando automaticamente conforme necessário para contribuir com a sustentabilidade e inovação tecnológica.





PANEL SOLAR / SOLAR PANEL / PANNEAU SOLAIRE / PAINEL SOLAR



Ñ/ Panel solar monocristalino 18V- 20/ 38W.

Contribuye a la reducción de emisiones de carbono y asegura un suministro energético ininterrumpido.

F/ Panneau solaire monocristallin 18V- 20/ 38W.

Contribue à la réduction des émissions de carbone et assure un approvisionnement énergétique ininterrompu.

E/ Monocrystalline solar panel 18V- 20/ 38W.

Contributes to the reduction of carbon emissions and ensures an uninterrupted energy supply.

P/ Paine solar monocristalino 18V- 20/ 38W.

Contribui para a redução das emissões de carbono e assegura um fornecimento ininterrupto de energia.



BATERÍA / BATTERY / BATTERIE / BATERIA

Ñ/ Equipada con batería de fosfato de hierro y litio (LiFePo4), poseen una vida útil prolongada y un reemplazo sencillo.

F/ Équipés de batteries au phosphate de fer lithium (LiFePo4), ils ont une longue durée de vie et sont faciles à remplacer.

E/ Equipped with lithium iron phosphate (LiFePo4) batteries, it has a long lifespan and easy replacement.

P/ Equipados com baterias de fosfato de ferro e lítio (LiFePo4), têm uma longa vida útil e são fáceis de substituir.

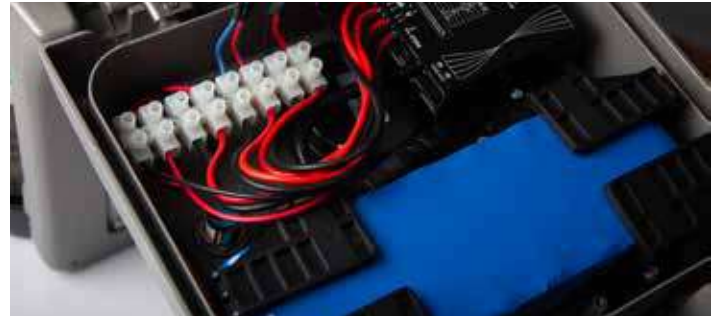

SISTEMA DE REGULACIÓN Y SUPERVISIÓN/ REGULATION AND SUPERVISION/ SYSTÈME DE RÉGLEMENTATION ET DE SURVEILLANCE/ SISTEMA DE REGULAMENTAÇÃO E DE CONTROLO



Ñ/ Este sistema ajusta los perfiles de emisión lumínicos configurables por MPPT (Maximum Power Point Tracking)

F/ Ce système ajuste les profils d'émission de lumière configurables par MPPT (Maximum Power Point Tracking).

E/ This system adjusts the configurable light emission profiles by MPPT (Maximum Power Point Tracking)

P/ Este sistema ajusta os perfis de emissão luminosa configuráveis por MPPT (Maximum Power Point Tracking).

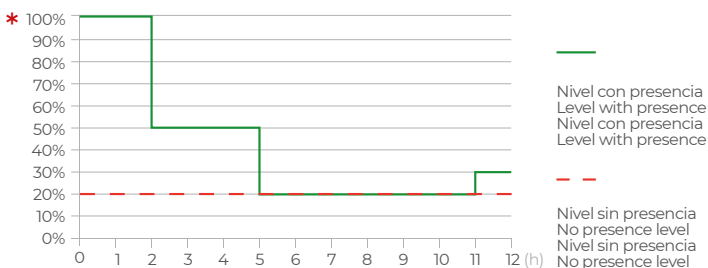

Nebira

N NEW	CIII	IP66	IK09	5 Años (Batería, Bateria, Batterie, Battery) 10 Años (Panel, Panel , Panneau, Paine)	-10~+45°C
-----------------	------	------	------	---	-----------

Solar
Solar
Solaire
Solar

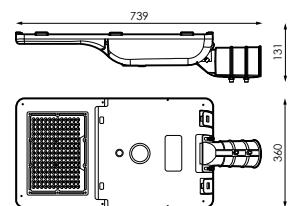

30,5W

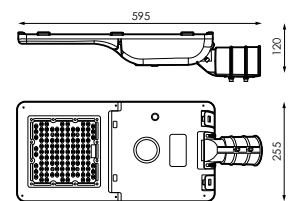

14,5W

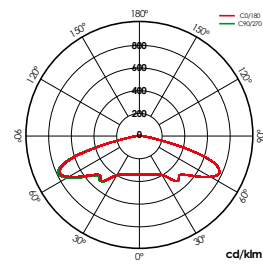

14,5W



INFORMACIÓN / INFORMATION / INFORMATION / INFORMAÇÕES

Ñ/ Batería
reemplazable

E/ Batería
reemplazable

F/ Batería
reemplazable

P/ Batería
reemplazable

ACCESORIOS / ACCESSOIRES / ACCESSORIES / ACESSÓRIOS



640534

INC. 1ud

Mando programador
Controller control
Contrôle du contrôleur
Controlo do controlador

DATOS COMUNES/
COMMON DATA/
DONNÉES COMMUNES/
DADOS COMUNS

☀️ PC

🌿 >70

☀️ 0,0%

🌀 RAL 9007

📐 VT-T

📄 AL iap



DATOS REFERENCIAS/ REFERENCE DATA/
RÉFÉRENCES DE DONNÉES/ REFERÊNCIAS DE DADOS

	W _t	K	φ _t	φ/W	☀️
*636537	14,5W	3.000K	2.759lm	190lm/W	112
*636544	14,5W	4.000K	2.972lm	205lm/W	112
*636551	30,5W	3.000K	5.912lm	193lm/W	180
*636575	30,5W	4.000K	6.192lm	203lm/W	180



Spaces



Silaya IP65



CI	IP65	IK08	L80B10>150.000h L90B10>74.000h	-30~+35°C
----	------	------	-----------------------------------	-----------

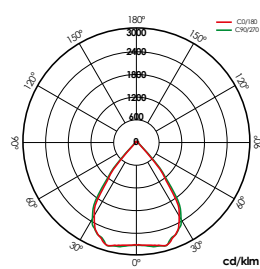
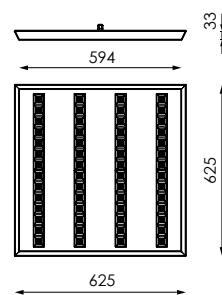
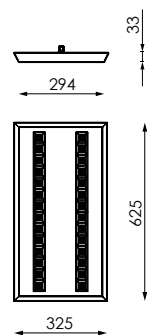
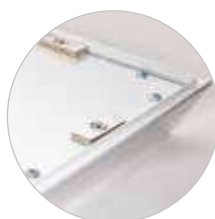

AL-BR

[GRÁFICOS: Unidades en mm/ GRAPHICS: Units in mm/GRAPHIQUES: Unités en mm/GRÁFICOS: Unidades em mm]

DATOS COMUNES/
COMMON DATA/
DONNÉES COMMUNES/
DADOS COMUNS

⚡ 220-240V

Hz 50-60Hz

🔌 300mA

K 4.000K

📺 UGR <19

🌿 >80

💡 112

🌀 RAL 9016

📏 VT-T

☒ AL-BR

📦 AL termoesmaltado con
pintura en polvo

☀️ PMMA-T

📦 2x - 4,7Kg
4x - 8,2Kg

↑ Superficie
(Techos Metálicos)



MADE IN SPAIN
Design by PRILUX

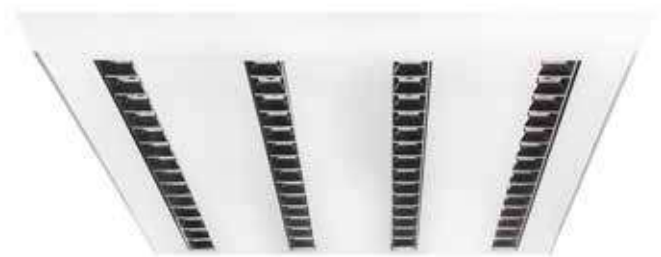

DATOS REFERENCIAS/ REFERENCE DATA/
RÉFÉRENCES DE DONNÉES/ REFERÊNCIAS DE DADOS

📏	W_{LED}	W_T	ϕ	ϕ_{LED}	ϕ_T	ϕ/W	💡	☒	↕
623438	48W	52,0W	0,98	8.358lm	7.522lm	145lm/W	224	AL-BR	625x 625 x 33mm
623445	24W	26,0W	0,96	4.179lm	3.761lm	145lm/W	112	AL-BR	625x 325 x 33mm



Altha

Nuevo spotlight modular



Altha

N/ El nuevo Altha es un spotlight modular completamente adaptable y personalizable a los requerimientos lumínicos y estéticos del lugar de la instalación proporcionando el máximo confort visual.

Sus características lo convierten en el spotlight perfecto que combina diseño, elegancia y versatilidad para su uso en lugares donde se requiere un enfoque preciso.

Permite una configuración a demanda gracias a la variedad de accesorios. Eligiendo el motor lumínico puedes cambiar la lente, la potencia, los marcos y los reflectores, de forma fácil y sencilla, en función de la aplicación o instalación: empotrar, superficie o suspensión.

E/ The new Altha is a fully adaptable and customizable modular spotlight designed to meet the lighting and aesthetic requirements of any installation site, providing maximum visual comfort.

Its features make it the perfect spotlight, combining design, elegance, and versatility for use in environments where precise lighting is essential

It allows for on-demand configuration thanks to its variety of accessories. By selecting the light engine, you can easily and simply change the lens, power, frames, and reflectors according to the application or installation requirements, whether it be recessed, surface-mounted, or pendant.pendant.

F/ Le nouvel Altha est un projecteur modulaire totalement adaptable et personnalisable aux exigences d'éclairage et d'esthétique du lieu d'installation, offrant un confort visuel maximal.

Ses caractéristiques en font le projecteur parfait qui allie design, élégance et polyvalence pour une utilisation dans des lieux où une mise au point précise est nécessaire.

Il permet une configuration à la demande grâce à la variété des accessoires. En choisissant le moteur lumineux, il est possible de changer facilement et simplement la lentille, la puissance, les cadres et les réflecteurs, en fonction de l'application ou de l'installation : encastrée, en surface ou suspendue.

P/ O novo Altha é um projetor modular totalmente adaptável e personalizável às necessidades de iluminação e estéticas do local de instalação, proporcionando o máximo conforto visual.

As suas características fazem dele o projetor perfeito que combina design, elegância e versatilidade para utilização em locais onde é necessária uma focagem precisa.

Permite a configuração a pedido graças à variedade de acessórios. Ao escolher o motor de iluminação, é possível mudar a lente, a potência, as molduras e os reflectores de forma fácil e simples, em função da aplicação ou da instalação: encastrada, de superfície ou suspensa.

¿COMO CONFIGURAR TU SPOTLIGHT?
HOW TO CONFIGURE YOUR SPOTLIGHT?
COMMENT CONFIGURER VOTRE PROJECTEUR?
COMO CONFIGURAR O SEU PROJETO?

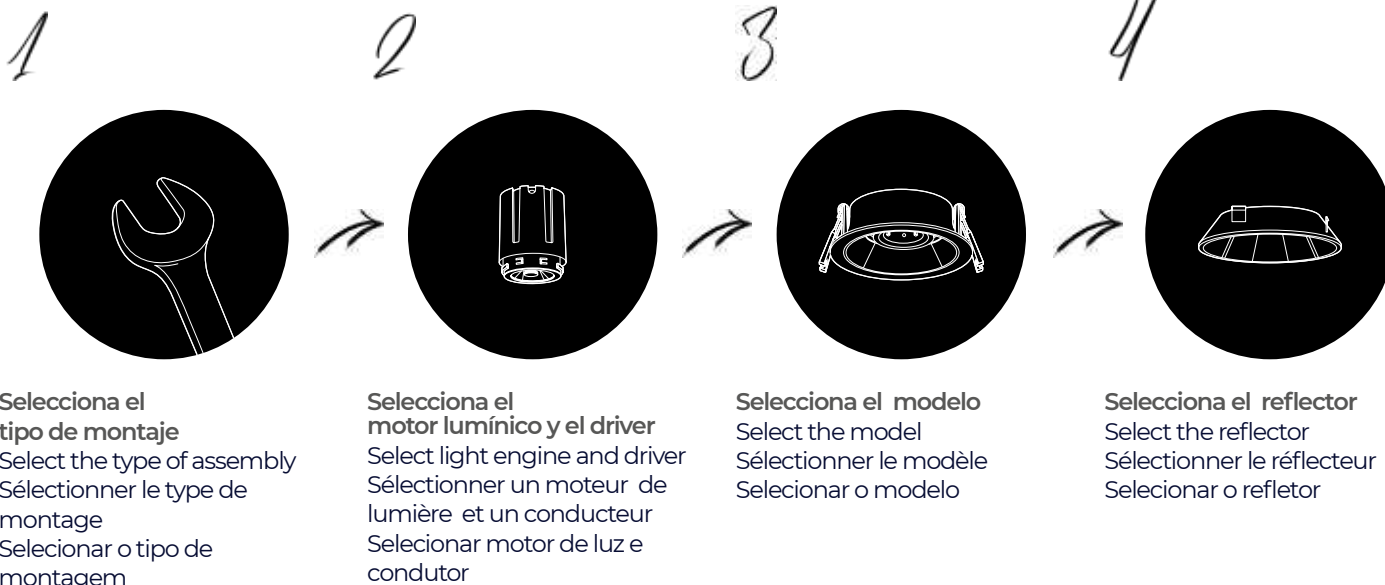

Empotrar CL
Recessed CL
CL encastré
CL embutido

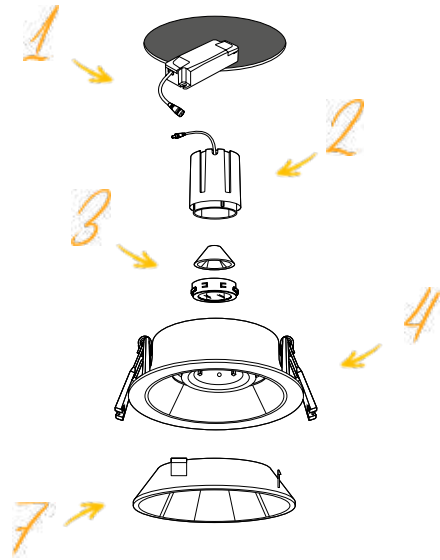

Empotrar SQ
Recessed SQ
SQ encastré
SQ embutido

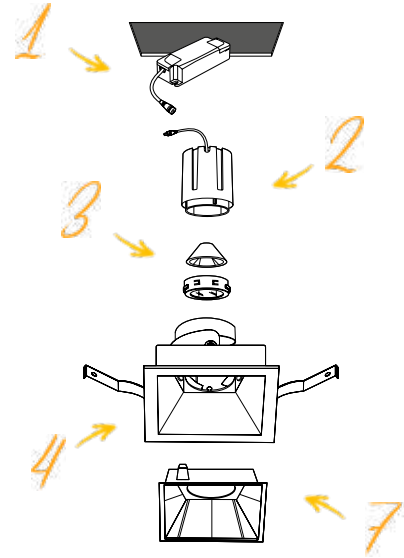

Suspender
Pendant
Suspendre
Suspensão

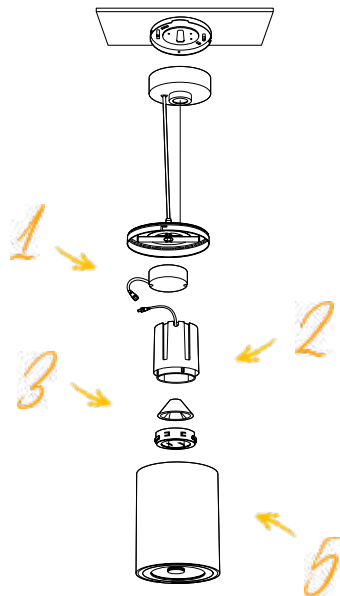

Superfície
Surface
Surface
Superfície

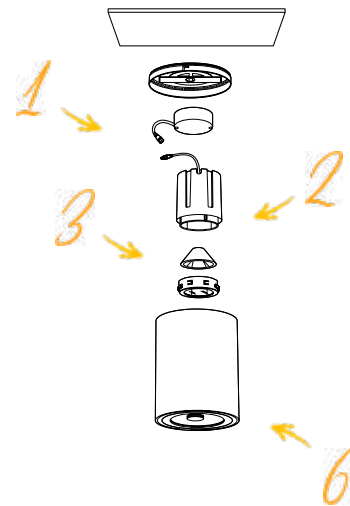

1 Driver
Driver
Driver
Driver

3 Lente
Lens
Lentille
Lente

5 Accesorio de suspender
Pendant accessory
Accessoire de suspension
Acessório de suspensão

7 Reflector
Reflector
Réflecteur
Refletor

2 Motor lumínico
Light engine
Moteur de lumière
Motor de luz

4 Marco de empotrar
Recessed frame
Cadre d'encastrement
Estrutura de encastrar

6 Accesorio de superficie
Surface accessory
Accessoire de surface
Acessório de superfície

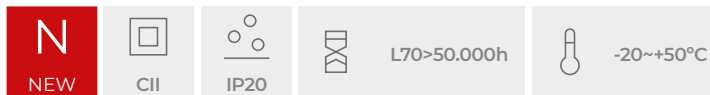

ACCESORIOS / ACCESSOIRES / ACCÉSSORIES / ACESSÓRIOS

+ INFO PAG. 100

	588010 INC. 1ud Lente 20° 20° Lens Lentille de 20° Lente de 20°		588027 INC. 1ud Lente 50° 50° Lens Lentille de 50° Lente de 50°
	588034 INC. 1ud Accesorio Superficie RAL9016 Texturizado Surface Accessory RAL9016 Texturised Cadre Saillie RAL9016 Texturé Superfície do acessório RAL9016 Texturado		588041 INC. 1ud Accesorio Superficie RAL9005 Texturizado Surface Accessory RAL9005 Texturised Cadre Saillie RAL9005 Texturé Superfície do acessório RAL9005 Texturado
	588058 INC. 1ud Accesorio Suspende RAL9016 Texturizado Pendant accessory RAL9016 Texturised Accessoire pour bretelles RAL9016 Texturé Acessório para suspensórios RAL9016 Texturado		588065 INC. 1ud Accesorio Suspende RAL9005 Texturizado Pendant accessory RAL9005 Texturised Accessoire pour bretelles RAL9005 Texturé Acessório para suspensórios RAL9005 Texturado
	587907 INC. 1ud Marco CL RAL9016 Texturizado Frame CL RAL9016 Textured Cadre CL RAL9016 Texturé Moldura CL RAL9016 Texturizada		587877 INC. 1ud Marco CL RAL9005 Texturizado Frame CL RAL9005 Textured Cadre CL RAL9005 Texturé Moldura CL RAL9005 Texturizada
	587914 INC. 1ud Marco SQ RAL9016 Texturizado Frame SQ RAL9016 Textured Cadre SQ RAL9016 Texturé Moldura SQ RAL9016 Texturizada		587891 INC. 1ud Marco SQ RAL9005 Texturizado Frame SQ RAL9005 Textured Cadre SQ RAL9005 Texturé Moldura SQ RAL9005 Texturizada
	587945 INC. 1ud Reflector CL Aluminio Brillo Reflector CL Aluminium Bright Réflecteur CL Aluminium brillant Refletor CL Alumínio brilhante		587952 INC. 1ud Reflector CL Aluminio Mate Reflector CL Aluminium Matt Réflecteur CL Aluminium mat Refletor CL Alumínio Mate
	587938 INC. 1ud Reflector CL Negro Mate Reflector CL Matt Black Réflecteur CL noir mat Refletor CL Preto mate		587990 INC. 1ud Reflector CL Sin Metalizar Reflector CL Unmetallised Réflecteur CL Non métallisé Refletor CL Não metalizado
	587976 INC. 1ud Reflector SQ Aluminio Brillo Reflector SQ Aluminium Bright Réflecteur SQ Aluminium brillant Refletor SQ Alumínio brilhante		587983 INC. 1ud Reflector SQ Aluminio Mate Reflector SQ Aluminium Mat Réflecteur SQ Aluminium Mat Refletor SQ Alumínio Mate
	587969 INC. 1ud Reflector SQ Negro Mate Reflector SQ Matt Black Réflecteur SQ noir mat Refletor SQ Preto mate		588003 INC. 1ud Reflector SQ Sin Metalizar Reflector SQ Unmetallised Réflecteur SQ Non métallisé Refletor SQ Não metalizado

DATOS COMUNES/
COMMON DATA/
DONNÉES COMMUNES/
DADOS COMUNS

⚡ 220-240V

Hz 50-60Hz

Φ ≤1.0

🌿 >80

△ 38°

⊙ GR

📄 AL

📄 PC



DATOS REFERENCIAS/ REFERENCE DATA/
RÉFÉRENCES DE DONNÉES/ REFERÊNCIAS DE DADOS

MOTOR LUMÍNICO/ LIGHT ENGINE/ MOTEUR DE LUMIÈRE / MOTOR DE LUZ

Barcode	W _T	Φ _T	K
587785	6W	660lm	3.000K
	9W	990lm	3.000K
	15W	1.650lm	3.000K
587846	6W	660lm	4.000K
	9W	990lm	4.000K
	15W	1.650lm	4.000K

DRIVER

Barcode	Icon	W _T	Icon
619745	Superficie/ Suspende	9W	200mA
587853	Empotrar	6W	150mA
587860	Empotrar	9W	200mA
619554	Empotrar	15W	350mA



MOTOR LUMÍNICO
LIGHT ENGINE
MOTEUR DE LUMIÈRE
MOTOR DE LUZ

BAJO PEDIDO / ON REQUEST / SUR COMMANDE / A PEDIDO



DALI



Altha L

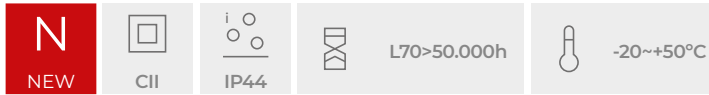

ACCESORIOS / ACCESSOIRES / ACCÉSSORIES / ACESSÓRIOS

+ INFO PAG. 100



*642484 INC. 1ud

Lente 24°
24° Lens
Lentille de 24°
Lente de 24°



*642477 INC. 1ud

Lente 35°
35° Lens
Lentille de 35°
Lente de 35°



*642491 INC. 1ud

Accesorio Superficie RAL9016
Texturizado
Surface Accessory RAL9016
Texturised
Cadre Saillie RAL9016 Texturé
Superfície do acessório RAL9016
Texturado



*642507 INC. 1ud

Accesorio Superficie RAL9005
Texturizado
Surface Accessory RAL9005
Texturised
Cadre Saillie RAL9005 Texturé
Superfície do acessório RAL9005
Texturado



*642385 INC. 1ud

Marco CL RAL9016 Texturizado
Frame CL RAL9016 Textured
Cadre CL RAL9016 Texturé
Moldura CL RAL9016 Texturizada



*642378 INC. 1ud

Marco CL RAL9005 Texturizado
Frame CL RAL9005 Textured
Cadre CL RAL9005 Texturé
Moldura CL RAL9005 Texturizada



*642408 INC. 1ud

Marco SQ RAL9016 Texturizado
Frame SQ RAL9016 Textured
Cadre SQ RAL9016 Texturé
Moldura SQ RAL9016 Texturizada



*642392 INC. 1ud

Marco SQ RAL9005 Texturizado
Frame SQ RAL9005 Textured
Cadre SQ RAL9005 Texturé
Moldura SQ RAL9005 Texturizada



*642422 INC. 1ud

Reflector CL Aluminio Brillo
Reflector CL Aluminium Bright
Réflecteur CL Aluminium brillant
Refletor CL Aluminio brilhante



*642439 INC. 1ud

Reflector CL Aluminio Mate
Reflector CL Aluminium Matt
Réflecteur CL Aluminium Mat
Refletor CL Aluminio Mate



*642415 INC. 1ud

Reflector CL Negro Mate
Reflector CL Matt Black
Réflecteur CL noir mat
Refletor CL Preto mate



*642453 INC. 1ud

Reflector SQ Aluminio Brillo
Reflector SQ Aluminium Bright
Réflecteur SQ Aluminium brillant
Refletor SQ Aluminio brilhante



*642460 INC. 1ud

Reflector SQ Aluminio Mate
Reflector SQ Aluminium Matt
Réflecteur SQ Aluminium Mat
Refletor SQ Aluminio Mate



*642446 INC. 1ud

Reflector SQ Negro Mate
Reflector SQ Matt Black
Réflecteur SQ noir mat
Refletor SQ Preto mate

DATOS COMUNES/
COMMON DATA/
DONNÉES COMMUNES/
DADOS COMUNS

⚡ 220-240V

Hz 50-60Hz

Φ ≤1.0

🌿 >80

△ 50°

⊙ GR

📦 AL

📏 PC



DATOS REFERENCIAS/ REFERENCE DATA/
RÉFÉRENCES DE DONNÉES/ REFERÊNCIAS DE DADOS

MOTOR LUMÍNICO/ LUMINIC MOTOR/ MOTEUR DE LUMIÈRE / MOTOR DE LUZ

▮	W _T	Φ _T	K
*642354	24W	2640lm	3.000K
*642361	24W	2640lm	4.000K

DRIVER

▮	📏	W _T	📦
*644624	Superficie	20W	500mA
*644075	Empotrar	24W	600mA



MOTOR LUMÍNICO
LIGHT ENGINE
MOTEUR DE LUMIÈRE
MOTOR DE LUZ

BAJO PEDIDO / ON REQUEST / SUR COMMANDE / A PEDIDO



DALI



*Consultar disponibilidad/ *Check availability/ *Vérifier la disponibilité/ *Verificar disponibilidade

Accesorios

Accessories

Accessoires

Acessórios

	Altha	Altha L
588034	•	
588041	•	
587853	•	
587860	•	
587877	•	
587907	•	
587891	•	
587914	•	
587945	•	
587990	•	
587938	•	
587952	•	
587976	•	
588003	•	
587969	•	
587983	•	
588010	•	
588027	•	
*642507		•
*642491		•
*642378		•
*642385		•
*642392		•
*642408		•
*642422		•
*642439		•
*642415		•
*642453		•
*642460		•
*642446		•
*642484		•
*642477		•



588041 INC. 1ud

Accesorio Superficie RAL9005
Texturizado
Surface Accessory RAL9005
Texturised
Surface de l'accessoire RAL9005
Texturé
Superfície do acessório RAL9005
Texturado



588034 INC. 1ud

Accesorio Superficie RAL9016
Texturizado
Surface Accessory RAL9016
Texturised
Surface de l'accessoire RAL9016
Texturé
Superfície do acessório RAL9016
Texturado



588065 INC. 1ud

Accesorio Suspender RAL9005
Texturizado
Pendant accessory RAL9005 Texturised
Accessoire pour bretelles RAL9005
Texturé
Acessório para suspensórios RAL9005
Texturado



588058 INC. 1ud

Accesorio Suspender RAL9016
Texturizado
Pendant accessory RAL9016 Texturised
Accessoire pour bretelles RAL9016
Texturé
Acessório para suspensórios RAL9016
Texturado

*Consultar disponibilidad/ *Check availability/ *Vérifier la disponibilité/ *Verificar disponibilidade



587877 INC. 1ud
 Marco CL RAL9005 Texturizado
 Frame CL RAL9005 Textured
 Cadre CL RAL9005 Texturé
 Moldura CL RAL9005 Texturizada



587907 INC. 1ud
 Marco CL RAL9016 Texturizado
 Frame CL RAL9016 Textured
 Cadre CL RAL9016 Texturé
 Moldura CL RAL9016 Texturizada



587891 INC. 1ud
 Marco SQ RAL9005 Texturizado
 Frame SQ RAL9005 Textured
 Cadre SQ RAL9005 Texturé
 Moldura SQ RAL9005 Texturizada



587914 INC. 1ud
 Marco SQ RAL9016 Texturizado
 Frame SQ RAL9016 Textured
 Cadre SQ RAL9016 Texturé
 Moldura SQ RAL9016 Texturizada



587945 INC. 1ud
 Reflector CL Aluminio Brillo
 Reflector CL Aluminium Bright
 Réflecteur CL Aluminium brillant
 Refletor CL Alumínio brilhante



587952 INC. 1ud
 Reflector CL Aluminio Mate
 Reflector CL Aluminium Matt
 Réflecteur CL Aluminium Mat
 Refletor CL Alumínio Mate



587938 INC. 1ud
 Reflector CL Negro Mate
 Reflector CL Matte Black
 Réflecteur CL noir mat
 Refletor CL Preto mate



587990 INC. 1ud
 Reflector CL Sin Metalizar
 Reflector CL Unmetallised
 Réflecteur CL Non métallisé
 Refletor CL Não metalizado



587976 INC. 1ud
 Reflector SQ Aluminio Brillo
 Reflector SQ Aluminium Bright
 Réflecteur SQ Aluminium brillant
 Refletor SQ Alumínio brilhante



588003 INC. 1ud
 Reflector SQ Sin Metalizar
 Reflector SQ Unmetallised
 Réflecteur SQ Non métallisé
 Refletor SQ Não metalizado



587969 INC. 1ud
 Reflector SQ Negro Mate
 Reflector SQ Matte Black
 Réflecteur SQ noir mat
 Refletor SQ Preto mate



587983 INC. 1ud
 Reflector SQ Aluminio Mate
 Reflector SQ Aluminium Matt
 Réflecteur SQ Aluminium Mat
 Refletor SQ Alumínio Mate



*588010 INC. 1ud
 Lente 20°
 20° Lens
 Lentille de 20°
 Lente de 20°



*588027 INC. 1ud
 Lente 50°
 50° Lens
 Lentille de 50°
 Lente de 50°



*642507 INC. 1ud
 Accesorio Superficie RAL9005
 Texturizado
 Surface Accessory RAL9005
 Texturised
 Surface de l'accessoire RAL9005
 Texturé
 Superfície do acessório RAL9005
 Texturado



*642491 INC. 1ud
 Accesorio Superficie RAL9016
 Texturizado
 Surface Accessory RAL9016
 Texturised
 Surface de l'accessoire RAL9016
 Texturé
 Superfície do acessório RAL9016
 Texturado



*642378 INC. 1ud

Marco CL RAL9005 Texturizado
Frame CL RAL9005 Textured
Cadre CL RAL9005 Texturé
Moldura CL RAL9005 Texturizada



*642385 INC. 1ud

Marco CL RAL9016 Texturizado
Frame CL RAL9016 Textured
Cadre CL RAL9016 Texturé
Moldura CL RAL9016 Texturizada



*642392 INC. 1ud

Marco SQ RAL9005 Texturizado
Frame SQ RAL9005 Textured
Cadre SQ RAL9005 Texturé
Moldura SQ RAL9005 Texturizada



*642408 INC. 1ud

Marco SQ RAL9016 Texturizado
Frame SQ RAL9016 Textured
Cadre SQ RAL9016 Texturé
Moldura SQ RAL9016 Texturizada



*642422 INC. 1ud

Reflector CL Aluminio Brillo
Reflector CL Aluminium Bright
Réflecteur CL Aluminium brillant
Refletor CL Aluminio brilhante



*642439 INC. 1ud

Reflector CL Aluminio Mate
Reflector CL Aluminium Matt
Réflecteur CL Aluminium Mat
Refletor CL Aluminio Mate



*642415 INC. 1ud

Reflector CL Negro Mate
Reflector CL Matt Black
Réflecteur CL noir mat
Refletor CL Preto mate



*642453 INC. 1ud

Reflector SQ Aluminio Brillo
Reflector SQ Aluminium Bright
Réflecteur SQ Aluminium brillant
Refletor SQ Aluminio brilhante



*642460 INC. 1ud

Reflector SQ Aluminio Mate
Reflector SQ Aluminium Matt
Réflecteur SQ Aluminium Mat
Refletor SQ Aluminio Mate



*642446 INC. 1ud

Reflector SQ Negro Mate
Reflector SQ Matt Black
Réflecteur SQ noir mat
Refletor SQ Preto mate



*642484 INC. 1ud

Lente 24°
24° Lens
Lentille de 24°
Lente de 24°



*642477 INC. 1ud

Lente 35°
35° Lens
Lentille de 35°
Lente de 35°

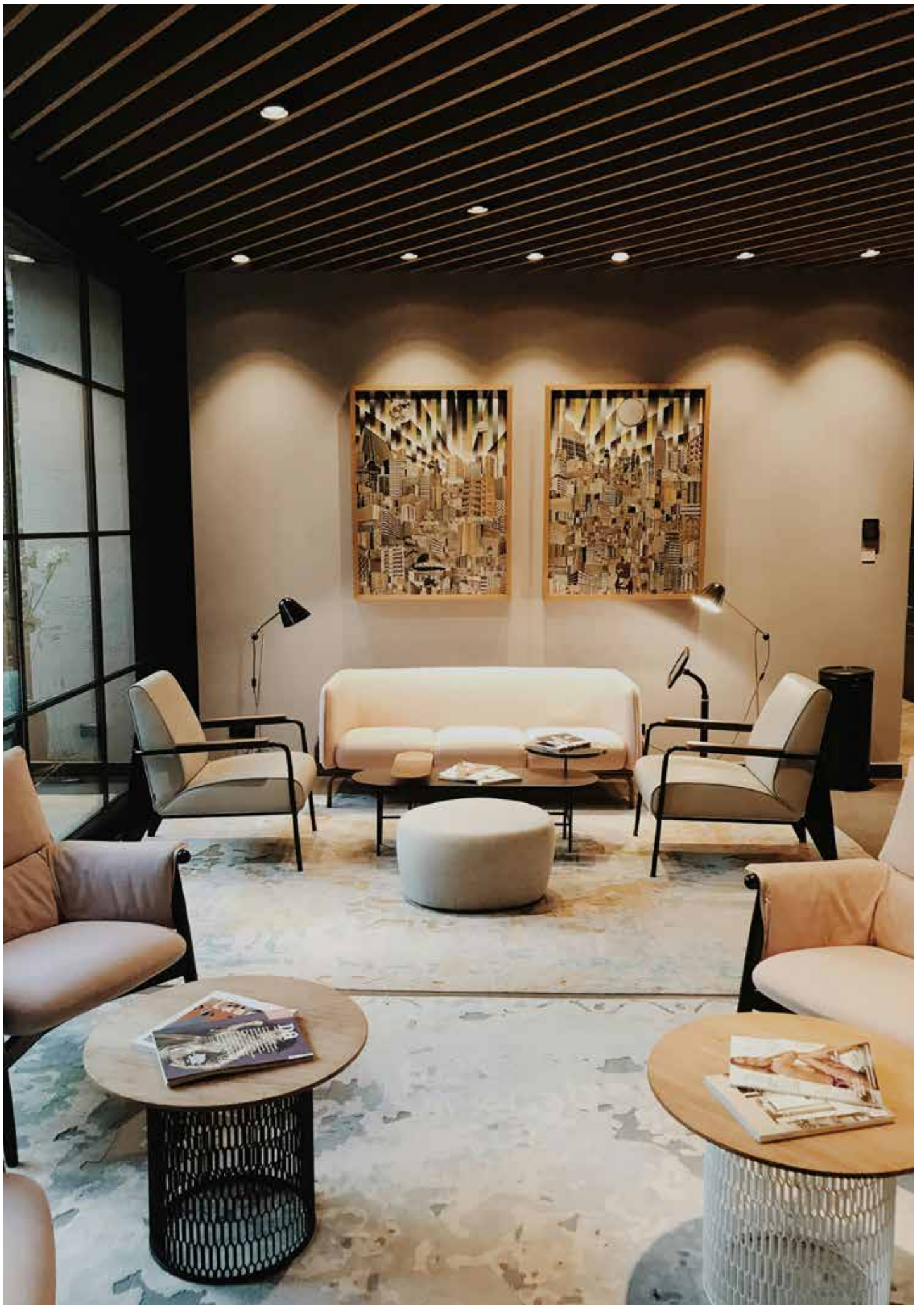



London

Brussels

8

09

Paris

FRANCE

Bern

SWITZERLAND

Lyon

MONACO

Bilbao

ANDORRA

Madrid

SPAIN

Valencia

Seville

ANDORRA

ANDORRA

MADE IN EUROPE

Productos bajo pedido



Consulta con el comercial de tu zona



Lámparas

lamps
lampes
lâmpadas



MADE IN EUROPE

ACTIVA



Berran



Reviat



Galai



Reinet

Especificaciones

	Aislamiento eléctrico	CII
	Tensión (V)	220-240V
Hz	Frecuencia (Hz)	50-60Hz
Φ	Factor de potencia	-
	Temp. de funcionamiento	-20°C~+45 °C
ϕ	Flujo luminoso (lm)	-
K	Temperatura de color	-
	Índice reproducción cromática	-
	Óptica	-
Δ	Ángulo de apertura	-
	Vida útil	-
	L70B50>	-
	Índice de estanqueidad	IP20
	Color	-
	Difusor	-
	Cuerpo	Aluminio
	Dimensiones	-
	Posición de montaje	Suspender



Apliques Lineales

Linear appliques
Appliques linéaires
Apliques lineares

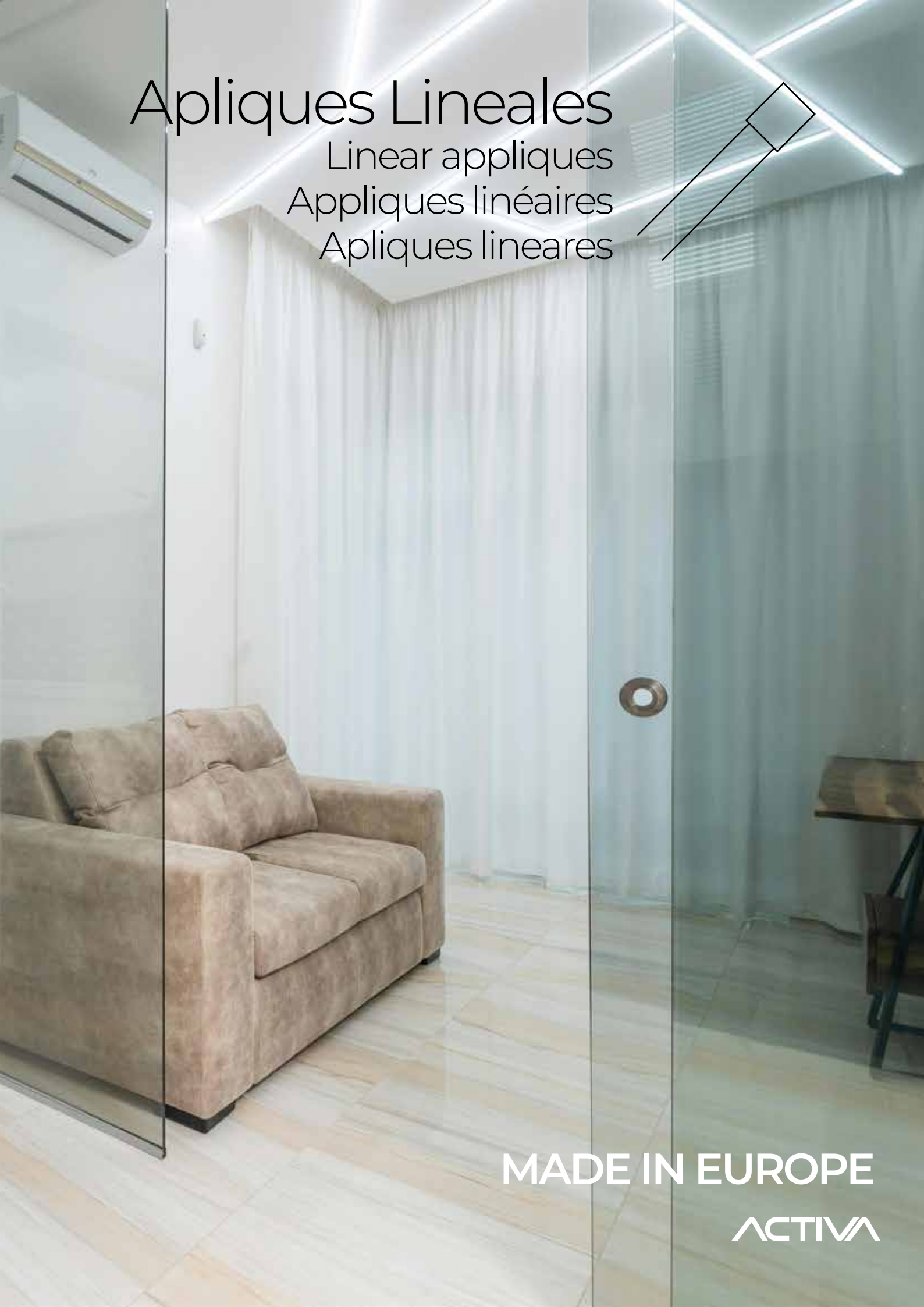
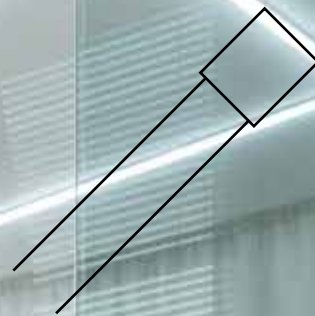

MADE IN EUROPE

ACTIVA



Especificaciones



	Garantía	Hasta 3 años de garantía
	Aislamiento eléctrico	CII
	Tensión (V)	220-240V
Hz	Frecuencia (Hz)	50-60Hz
Φ	Factor de potencia	>0,9
	Temp. de funcionamiento	-20°C~+40 °C
ϕ	Flujo luminoso (lm)	3.060lm
K	Temperatura de color	4.000K
	Índice reproducción cromática	>80
	Óptica	-
	Ángulo de apertura	120°
	Vida útil	36.000h
	L70B50>	36.000h
	Índice de estanqueidad	IP40
	Protección contra impactos	IK08
	Color	Negro
	Difusor	PC-O: Policarbonato Opal
	Cuerpo	Aluminio
	Dimensiones	1020x33x60mm
	Posición de montaje	Superficie
		Suspender
	Unidad de Embalaje	12

[GRÁFICOS: Unidades en mm/ GRAPHICS: Units in mm/ GRÁFICOS: Unidades em mm]

Referencias

W_T	ϕ_T		K	\leftrightarrow
36W	3.060lm	4	4.000K	1020x33x60mm

Dimensiones

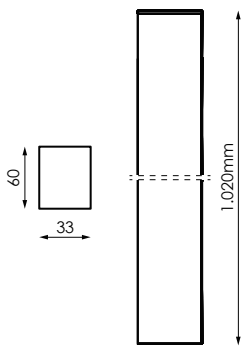

Fotometría

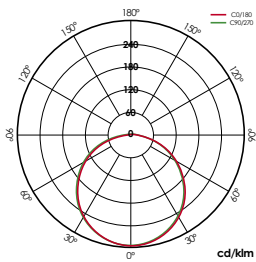

Bajo pedido

Configuración

Kit de emergencia

Color

Disponibles colores carta RAL
(consultar)



Downlights

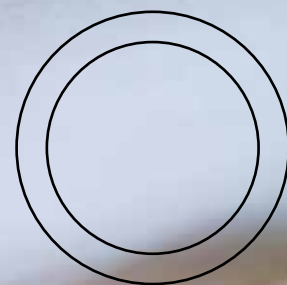

MADE IN EUROPE

ACTIVA

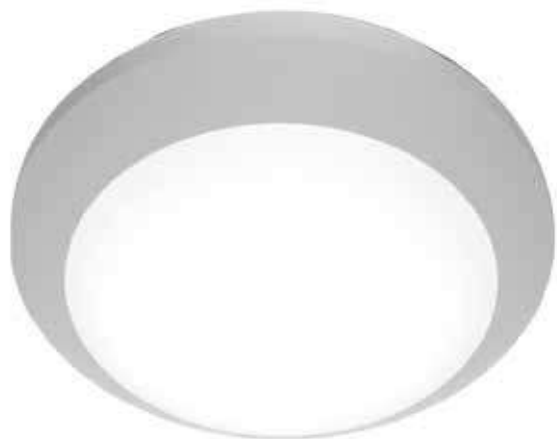

Especificaciones

	Aislamiento eléctrico	CII
	Tensión (V)	220-240V ac
Hz	Frecuencia (Hz)	50-60Hz
Φ	Factor de potencia	>0,95
	Temp. de funcionamiento	-20°C~+45°C
ϕ	Flujo luminoso (lm)	
K	Temperatura de color	4.000K
	Índice reproducción cromática	>80
Δ	Ángulo de apertura	120°
	Vida útil	50.000h
	L70B50	50.000h
	Índice de estanqueidad	IP66
	Color	-
	Difusor	PC-O: Policarbonato opal
	Cuerpo	Inyección de polímero
	Dimensiones	Ø260 X 87mm
	Posición de montaje	Luminaria de superficie

Referencias

	W_T	ϕ_T	ϕ/W		K	\leftrightarrow
LED	15W	1.605lm	107lm/W	4	4.000K	Ø260 X 87mm
LED+SENSOR	15W	1.605lm	107lm/W	4	4.000K	Ø260 X 87mm
LED+EMERGENCIA	15W	1.605lm	107lm/W	4	4.000K	Ø260 X 87mm
LED+EMERGENCIA+SENSOR	15W	1.605lm	107lm/W	4	4.000K	Ø260 X 87mm

Dimensiones

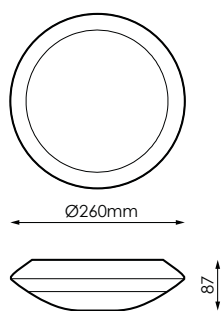



Sorat S



Sorat M



Sorat L









Especificaciones

Garantía		Hasta 2 años de garantía
	Aislamiento eléctrico	CII
	Tensión (V)	220-240V ac
Hz	Frecuencia (Hz)	50-60Hz
Φ	Factor de potencia	>0,9
	Temp. de funcionamiento	-20°C~+45°C
ϕ	Flujo luminoso (lm)	Hasta 3.570lm
K	Temperatura de color	4.000K
	Índice reproducción cromática	>80
	Riesgo fotobiológico	RG1
	Óptica	-
Δ	Ángulo de apertura	30°
	Vida útil	50.000h
L_{70}	L70	>50.000h
	Índice de estanqueidad	IP20
	Resistencia al impacto	-
\odot	Color	RAL 9005/9016
	Difusor	VT: Vidrio transparente
	Reflector	AL: Aluminio
	Cuerpo	Aluminio
	Dimensiones	Ø153x125mm
	Corte	Ø102mm
	Posición de montaje	Empotrar
	Unidad de Embalaje	1



Referencias

	W_{LED}	ϕ_T	ϕ/W		K	\leftrightarrow	
Sorat S	8W	832lm	104lm/W		4.000K	$\phi 100 \times 82$ mm	$\phi 90$ mm
Sorat M	20W	2.080lm	104lm/W		4.000K	$\phi 144 \times 136$ mm	$\phi 135$ mm
Sorat M	30W	3.090lm	103lm/W		4.000K	$\phi 144 \times 136$ mm	$\phi 135$ mm
Sorat L	35W	3.570lm	102lm/W		4.000K	$\phi 178 \times 142$ mm	$\phi 170$ mm

Dimensiones

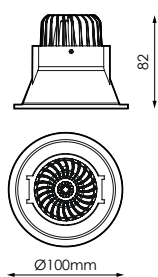

Sorat S

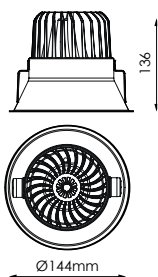

Sorat M

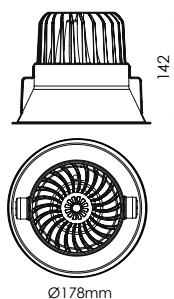

Sorat L

Bajo pedido

Regulación



Configuración

Kit de emergencia

Índice de reproducción cromática

Ra >90



Velium CL



Velium SQ





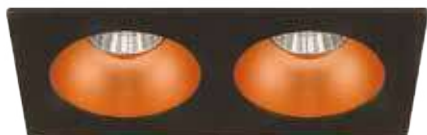



Velium SQ 2X



Especificaciones

Garantía		Hasta 2 años de garantía
	Aislamiento eléctrico	Cl
	Tensión (V)	220-240V
Hz	Frecuencia (Hz)	50-60Hz
Φ	Factor de potencia	>0,50
	Temp. de funcionamiento	-5°C~+35 °C
ϕ	Flujo luminoso (lm)	Hasta 1.080lm
K	Temperatura de color	4.000K
	Índice reproducción cromática	>80
	Riesgo fotobiológico	RG1
Δ	Ángulo de apertura	30°
	Vida útil	50.000h
	L70B50>	L70>50.000h
	Índice de estanqueidad	IP20
	Protección contra impactos	-
	Color	RAL 9005/9016
	Difusor	VT: Vidrio transparente
	Refle tor	AL: Aluminio
	Cuerpo	AL: Aluminio
	Posición de montaje	Empotrar
	Unidad de Embalaje	1

Referencias

	W_T	ϕ_T	ϕ/W		K		
Velium CL	8W	587lm	73lm/W		4.000K	Ø115x90mm	Ø100mm
Velium SQ	8W	587lm	73lm/W		4.000K	115x115x90mm	100x100mm
Velium SQ 2x	2x8W	1.242lm	88lm/W		4.000K	215x115x100mm	215x115mm

Dimensiones

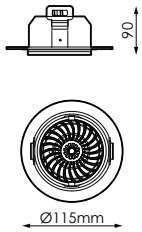

Velium CL

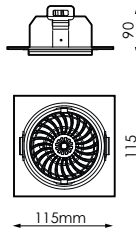

Velium SQ

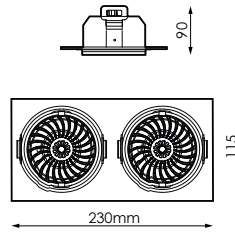

Velium SQ 2X

Bajo pedido

Regulación



Configuración

Kit de emergencia

Índice repr. cromática

Ra >90

Referencias

W_{LED}	ϕ_T	ϕ/W	Δ		K
30W	3.150lm	105lm/W	30°	4	4.000K

Dimensiones

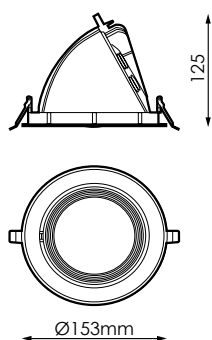

Bajo pedido

Regulación



Configuración

Kit de emergencia

Índice repr.ncromática

Ra >90



Especificaciones

	Garantía	Hasta 2 años de garantía
	Aislamiento eléctrico	CII
	Tensión (V)	220-240V ac
Hz	Frecuencia (Hz)	50-60Hz
Φ	Factor de potencia	>0,9
	Temp. de funcionamiento	-20°C~+45°C
ϕ	Flujo luminoso (lm)	1.774lm
K	Temperatura de color	4.000K
	Índice reproducción cromática	>80
	Riesgo fotobiológico	RG1
	Óptica	-
Δ	Ángulo de apertura	30°
	Vida útil	50.000h
	L70	>50.000h
	Índice de estanqueidad	IP20
	Resistencia al impacto	-
	Color	RAL 9005/9016
	Difusor	VT: Vidrio transparente
	Reflector	AL: Aluminio
	Cuerpo	Aluminio
	Dimensiones	140x145x85mm
	Corte	120x120mm
	Posición de montaje	Empotrar
	Unidad de Embalaje	1

Referencias

W_{LED}	ϕ_T	ϕ/W		K		
20W	1.774lm	88lm/W	4	4.000K	140x145x85lm	120x120mm

Dimensiones

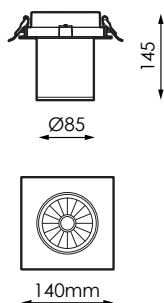

Bajo pedido

Regulación



Configuración

Kit de emergencia

Índice repr.ncromática

Ra >90



Pantallas
Panels
Des écrans
Paineis



MADE IN EUROPE

ACTIVA

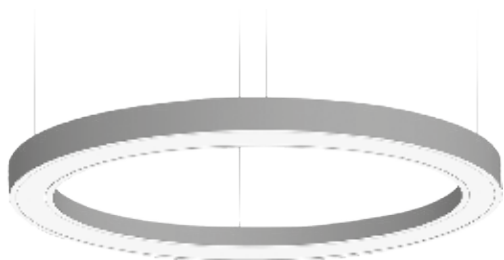

Exania CL DIRECT/INDIRECT



Exania CL PLUS

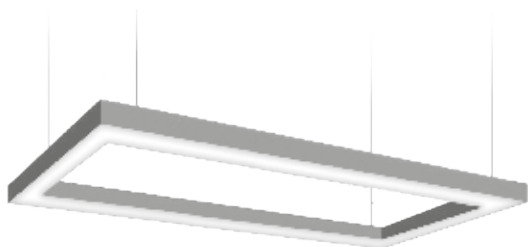

Exania RE DIRECT

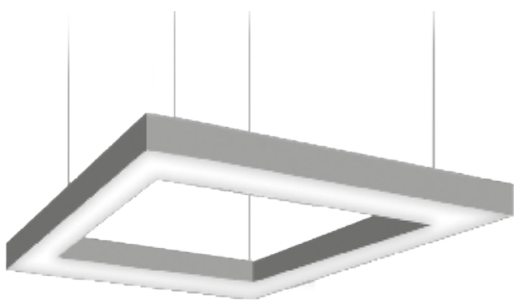







Exania SQ DIRECT

Especificaciones

Garantía		Hasta 5 años de garantía
	Aislamiento eléctrico	Cl
	Tensión (V)	230V ac
Hz	Frecuencia (Hz)	50-60Hz
Φ	Factor de potencia	>0,90
	Temp. de funcionamiento	-20°C~+45 °C
ϕ	Flujo luminoso (lm)	Hasta 9.200lm
K	Temperatura de color	4.000K
	Índice reproducción cromática	>80
Δ	Ángulo de apertura	150°
	Vida útil	L70>50.000h
	Índice de estanqueidad	IP40
	Resistencia al impacto (IKluminaria)	IK02
	Color	RAL 9006
	Difusor	PC-O: Polibarbonato opal
	Cuerpo	AL: Aluminio
	Dimensiones	1.250x650x82mm
	Posición de montaje	Superficie
		Suspender
	Unidad de Embalaje	1

Referencias

	W	ϕ	ϕ/W		K	\leftrightarrow (X-Y-Z)
Exania CL DIRECT/INDIRECT	47W	5.170lm	110lm/W		4.000K	400x80x80mm
Exania CL DIRECT	32W	3.520lm	110lm/W		4.000K	400x80x80
Exania CL PLUS	36W	4.140lm	115lm/W		4.000K	400x80mm
Exania SQ DIRECT	40W	4.600lm	115lm/W		4.000K	420x420x82mm
Exania RE DIRECT	80W	9.200lm	115lm/W		4.000K	1.250x650x82mm

Dimensiones

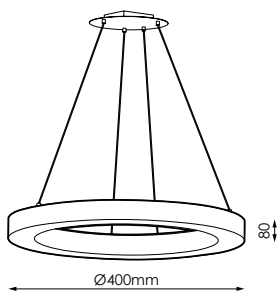

Exania CL DIRECT/INDIRECT

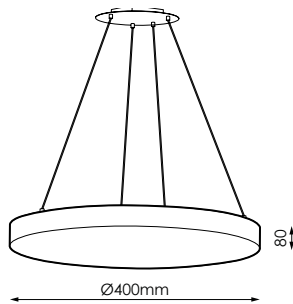

Exania CL PLUS

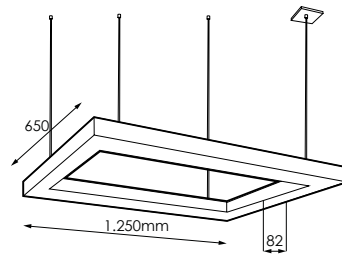

Exania RE DIRECT

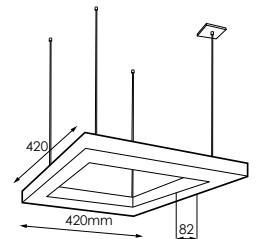

Exania SQ DIRECT

Fotometría

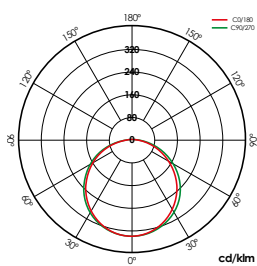

Bajo pedido

Regulación



1-10V

Configuración

Kit de emergencia 1h

Kit de emergencia 3h



City

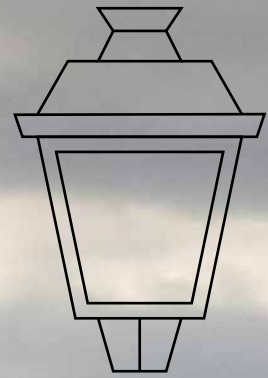

MADE IN EUROPE

ACTIVA



Especificaciones

	Garantía	Hasta 5 años de garantía
	Aislamiento eléctrico	Cl
	Tensión (V)	220-240V
Hz	Frecuencia (Hz)	50-60Hz
Φ	Factor de potencia	>0,90
	Temp. de funcionamiento	-20°C~+45 °C
ϕ	Flujo luminoso (lm)	Hasta 5.840lm
K	Temperatura de color	4.000K
	Índice reproducción cromática	>70
	Óptica	-
Δ	Ángulo de apertura	Simétrico/Asimétrico
	Vida útil	50.000h
	L70B50>	50.000h
	Índice de estanqueidad	IP65
	Protección contra impactos	IK08
	Color	RAL 7035
	Difusor	PC-UV
	Cuerpo	PC-UV
	Dimensiones	-
	Montaje	1. Brazo en paramento. 2. Brazo en fuste.



Referencias

W_T	ϕ_T	ϕ/W		K
40W	5.840lm	146lm/W	4	4.000K

Dimensiones

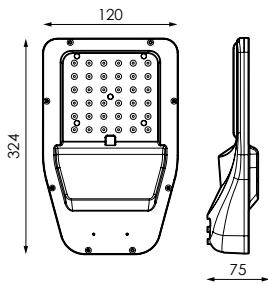

Fotometría

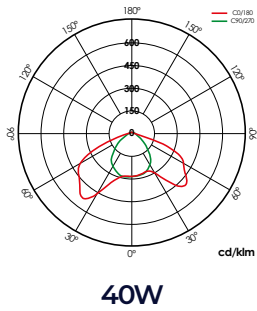

Montaje

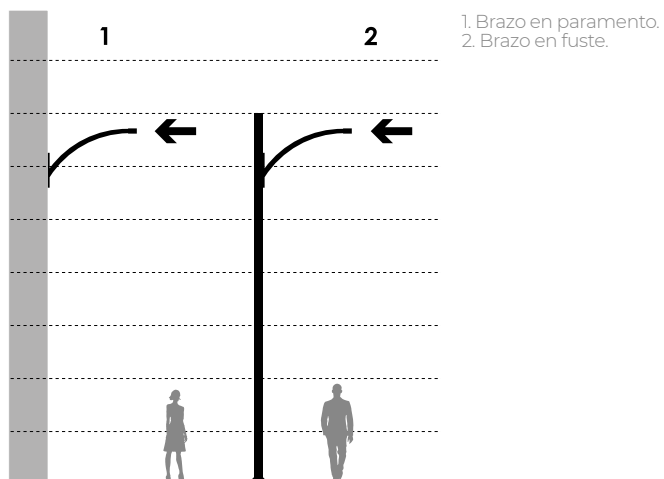



10

POANG
RM 449

10-04-20

10-05-20

POANG
RM 160

10

10
pyen
-06
x 10
n 04-06

POANG
↑
POANG
↓

Industrial



MADE IN EUROPE





ACTIVA







Especificaciones

	Garantía	Hasta 5 años de garantía
---	----------	--------------------------

	Tensión (V)	220-240V ac
Hz	Frecuencia (Hz)	50-60Hz
Φ	Factor de potencia	>0,95

	Aislamiento eléctrico	Cl
	Índice de estanqueidad	IP65
	Resistencia al impacto	IK08
	Temp. de funcionamiento	-20°C~+45 °C
	Ángulo de apertura	40°

ϕ	Flujo luminoso (lm)	Hasta 17.250lm
K	Temperatura de color	4.000K
	Índice reproducción cromática	>80
	Vida útil	50.000h
	L70B50	>50.000h

	Color	RAL 7043
	Difusor	VT-T: Vidrio templado transparente
	Cuerpo	AL: Aluminio

Modelo	Dimensiones	Peso
75-100W	870 x 86 x 178mm	6,3kg
150W	1.430 x 86 x 178mm	9,8kg

Referencias

W_T	ϕ_T	ϕ/W		K	\leftrightarrow
75W	9.000lm	120lm/W		4.000K	865 x 115 x 80mm
100W	11.500lm	115lm/W		4.000K	865 x 115 x 80mm
150W	17.250lm	115lm/W		4.000K	1.145 x 115 x 80mm

Dimensiones

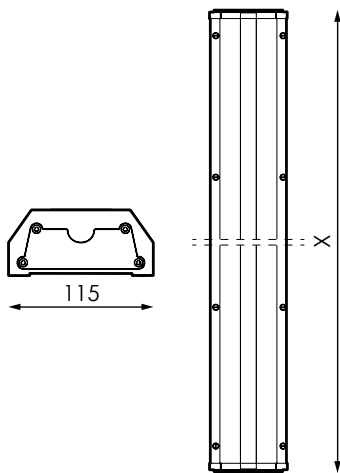

Fotometría

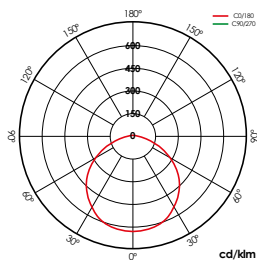

Bajo pedido

Configuración

Kit de emergencia

Sensor

Sensor de movimiento



City



MADE IN EUROPE
playtech



Ilunox R

Ilunox T

Especificaciones

	Garantía	Hasta 5 años de garantía
	Aislamiento eléctrico	Cl
	Tensión (V)	220-240V ac
Hz	Frecuencia (Hz)	50-60Hz
Φ	Factor de potencia	>0,90
	Temp. de funcionamiento	-20°C~+45°C
ϕ	Flujo luminoso (lm)	Hasta 11.700lm
K	Temperatura de color	4.000K
	Índice reproducción cromática	>70
	Óptica	PMMA
Δ	Ángulo de apertura	138/150°
	Vida útil	50.000h
	L70B50	50.000h
	Índice de estanqueidad	IP65
	Resistencia al impacto	IK10
	Color	RAL 9005/9006/7043
	Difusor	-
	Cuerpo	AL: Aluminio
	Dimensiones	-
	Peso	-
	Posición de montaje	Montaje vertical (suelo)
	Unidad de Embalaje	1

Referencias

Ilunox T

W_{LED}	ϕ_T	ϕ/W	K	\leftrightarrow	
50W	5.850lm	117lm/W	4.000K	3.000x220mm	62Kg
50W	5.850lm	117lm/W	4.000K	4.500x220mm	62Kg
100W	11.700lm	117lm/W	4.000K	4.500x220mm	67Kg

Ilunox R

W_{LED}	ϕ_T	ϕ/W	K	\leftrightarrow	
50W	5.850lm	117lm/W	4.000K	4.500x220mm	62Kg
100W	11.700lm	117lm/W	4.000K	4.500x220mm	67Kg

Dimensiones

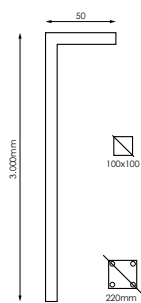

Ilunox T 50W

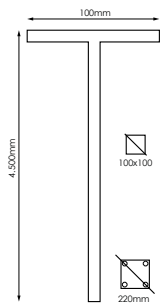

Ilunox T 100W

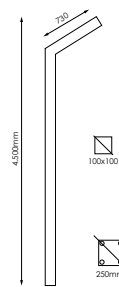

Ilunox R 50W

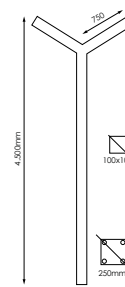

Ilunox R 100W

Fotometría

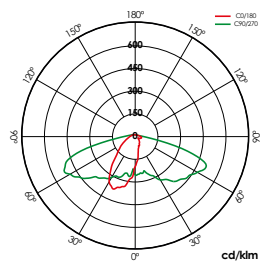

Asimétrica

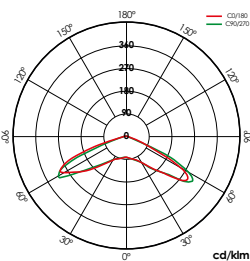

Simétrica

Bajo pedido

Regulación



Step DIM

Temperatura de color

3.000K

Acabado

Pintura ambientes salinos



Voxel



Voxel T PLUS

Especificaciones

	Garantía	Hasta 5 años de garantía
	Aislamiento eléctrico	Cl
	Tensión (V)	220-240V ac
Hz	Frecuencia (Hz)	50-60Hz
Φ	Factor de potencia	>0,90
	Temperatura de funcionamiento	-20°C~+40°C
ϕ	Flujo luminoso(lm)	Hasta 4.608lm
K	Temperatura de color	4.000K
	Índice de rep. cromática	>70
	Óptica	PMMA
Δ	Ángulo de apertura	-
	Horas de vida	50.000h
	L70B50	>50.000h
	Índice de estanqueidad	IP65
	protección contra impactos	IK08
	Color	RAL 9005/9006/7043
	Difusor	-
	Cuerpo	Aluminio
	Dimensiones	-
	Peso	-
	Posición de montaje	Montaje vertical (suelo)
	Unidades de embalaje	1

[GRÁFICOS: Unidades en mm/ GRAPHICS: Units in mm/ GRAPHIQUES: Units in mm/GRÁFICOS: Unidades en mm]

Referencias

Voxel

W_{LED}	ϕ_T	ϕ/W	K		
18W	2.304lm	128lm/W	4.000K	750x210x100x100mm	5,8kg

Voxel T PLUS

W_{LED}	ϕ_T	ϕ/W	K		
36W	4.608lm	128lm/W	4.000K	750x320x100x100mm	6,1kg

Dimensiones

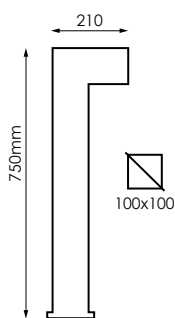

Voxel

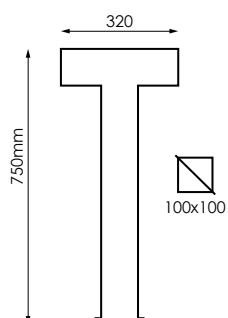

Voxel T PLUS

Fotometría

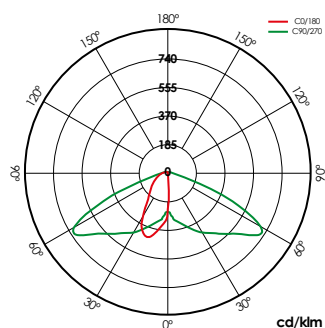



Industrial





MADE IN EUROPE
playtech

Especificaciones

	Garantía	Hasta 5 años de garantía
	Tensión (V)	220-240V ac
Hz	Frecuencia (Hz)	50-60Hz
Φ	Factor de potencia	>0,95
	Aislamiento eléctrico	Cl
	Índice de estanqueidad	IP65
	Resistencia al impacto	IK08
	Temp. de funcionamiento	-20°C~+45 °C
	Ángulo de apertura	120°
ϕ	Flujo luminoso (lm)	11.000lm
K	Temperatura de color	4.000K
	Índice reproducción cromática	>70
	Vida útil	>50.000h
	L70B50>	50.000h
	Dimensiones	400x400x100mm
	Peso	4,8kg
	Color	Blanco
	Difusor	VT-T: Vidrio templado transparente
	Cuerpo	AL: Aluminio



Referencias

W_T	ϕ_T	ϕ/W		K		
100W	11.000lm	110lm/W	4	4.000K	400x400x100mm	350x350mm

Dimensiones

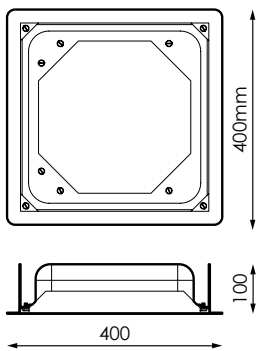

Fotometría

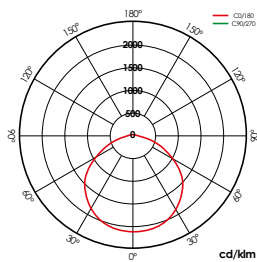

Bajo pedido

Regulación



1-10V

Touch DIM

Configuración

Kit de emergencia 1h

Kit de emergencia 3h













Especificaciones

	Garantía	Hasta 5 años de garantía
	Tensión (V)	220-240V ac
Hz	Frecuencia (Hz)	50-60Hz
Φ	Factor de potencia	>0,95
	Aislamiento eléctrico	Cl
	Índice de estanqueidad	IP65
	Resistencia al impacto	IK10
	Temp. de funcionamiento	-20°C~+45 °C
	Ángulo de apertura	40/55°
ϕ	Flujo luminoso (lm)	Hasta 38.400lm
K	Temperatura de color	4.000K
	Índice reproducción cromática	>80
	Vida útil	>50.000h
	L70B50>	50.000h
	Color	Gris
	Difusor	VT-T: Vidrio templado transparente
	Cuerpo	AL: Aluminio

Modelo	Dimensiones	Peso
100W	590 x 86 x 178mm	4,1kg
150W	870 x 86 x 178mm	6,3kg
200W	1.150 x 86 x 178mm	7,9kg
250-300W	1.430 x 86 x 178mm	9,8kg

Referencias

W_t	ϕ_t	ϕ/W	Δ		K	\leftrightarrow
100W	13.300lm	133lm/W	45°		4.000K	590x86x180mm
150W	19.950lm	133lm/W	45°		4.000K	870x86x180mm
200W	26.800lm	134lm/W	45°		4.000K	1.150x86x180mm
250W	33.250lm	133lm/W	45°		4.000K	1.430x86x180mm
300W	38.400lm	128lm/W	45°		4.000K	1.430x86x180mm
100W	13.300lm	133lm/W	55°		4.000K	590x86x180mm
150W	19.950lm	133lm/W	55°		4.000K	870x86x180mm
200W	26.800lm	134lm/W	55°		4.000K	1.150x86x180mm
250W	33.250lm	133lm/W	55°		4.000K	1.430x86x180mm
300W	38.400lm	128lm/W	55°		4.000K	1.430x86x180mm

Dimensiones

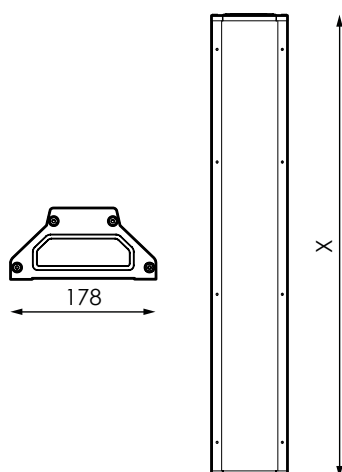

Fotometría

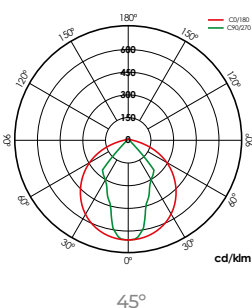
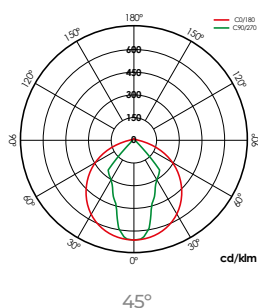

Bajo pedido

Aislamiento eléctrico

CII

Regulación



1-10V

Configuración

Kit de emergencia 1h







Kit de emergencia 3h

Sensor

Sensor de microondas







Especificaciones

	Garantía	Hasta 5 años de garantía
	Tensión (V)	220-240V ac
Hz	Frecuencia (Hz)	50-60Hz
Φ	Factor de potencia	>0,95
	Aislamiento eléctrico	Cl
	Índice de estanqueidad	IP65
	Resistencia al impacto	IK10
	Temp. de funcionamiento	-20°C~+45 °C
	Ángulo de apertura	45/55°
ϕ	Flujo luminoso (lm)	Hasta 38.400lm
K	Temperatura de color	4.000K
	Índice reproducción cromática	>80
	Vida útil	L70>50.000h
	L70B50>	L70>50.000h
	Color	-
	Difusor	VT-F: Vidrio templado filmado
	Cuerpo	AL: Aluminio

Modelo	Dimensiones	Peso
100W	590 x 86 x 178mm	4,1kg
150W	870 x 86 x 178mm	6,3kg
200W	1.150 x 86 x 178mm	7,9kg
250-300W	1.430 x 86 x 178mm	9,8kg

Referencias

W_T	ϕ_T	ϕ/W		K	\leftrightarrow
100W	13.300lm	133lm/W		4.000K	590 x 86 x 178mm
150W	19.950lm	133lm/W		4.000K	870 x 86 x 178mm
200W	26.800lm	134lm/W		4.000K	1.150 x 86 x 178mm
250W	33.250lm	133lm/W		4.000K	1.430 x 86 x 178mm
300W	38.400lm	128lm/W		4.000K	1.430 x 86 x 178mm

Dimensiones

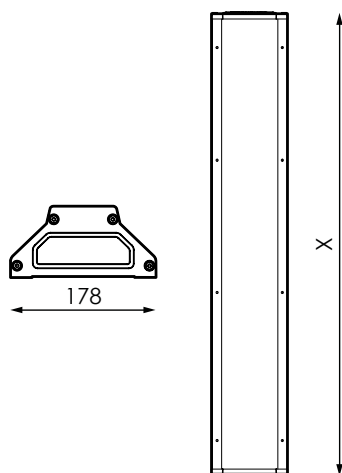

Fotometría

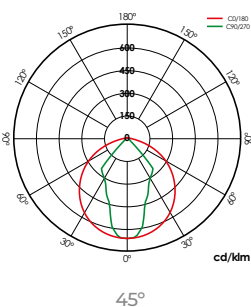
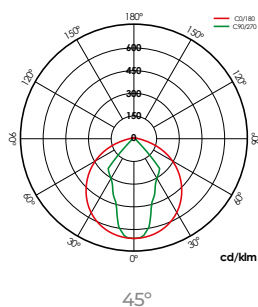

Bajo pedido

Aislamiento eléctrico

CII

Regulación



1-10V

Configuración

Kit de emergencia 1h

Kit de emergencia 3h

Sensor

Sensor de microondas



Especificaciones

	Garantía	Hasta 5 años de garantía
	Tensión (V)	220-240V ac
Hz	Frecuencia (Hz)	50-60Hz
Φ	Factor de potencia	>0,95
	Aislamiento eléctrico	Cl
	Índice de estanqueidad	IP65
	Resistencia al impacto	IK10
	Temp. de funcionamiento	-40°C~+55 °C
	Ángulo de apertura	45/55°
ϕ	Flujo luminoso (lm)	Hasta 38.400lm
K	Temperatura de color	4.000K
	Índice reproducción cromática	>80
	Vida útil	>50.000h
	L70B50>	L70>50.000h
	Color	-
	Difusor	VT-T: Vidrio templado transparente
	Cuerpo	AL: Aluminio

Modelo	Dimensiones	Peso
100W	590 x 86 x 178mm	4,1kg
150W	870 x 86 x 178mm	6,3kg
200W	1.150 x 86 x 178mm	7,9kg
250-300W	1.430 x 86 x 178mm	9,8kg

Referencias

W_T	ϕ_T	ϕ/W		K	\leftrightarrow
100W	13.300lm	133lm/W	4	4.000K	590 x 86 x 178mm
150W	19.950lm	133lm/W	4	4.000K	870 x 86 x 178mm
200W	26.800lm	134lm/W	4	4.000K	1.150 x 86 x 178mm
250W	33.250lm	133lm/W	4	4.000K	1.430 x 86 x 178mm
300W	38.400lm	128lm/W	4	4.000K	1.430 x 86 x 178mm

Dimensiones

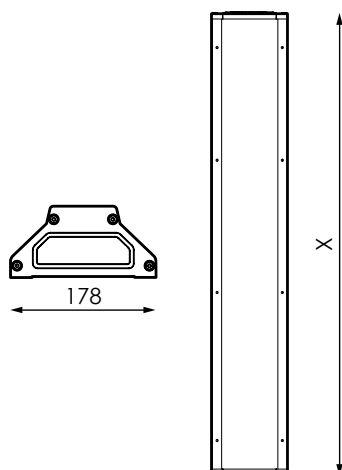

Fotometría

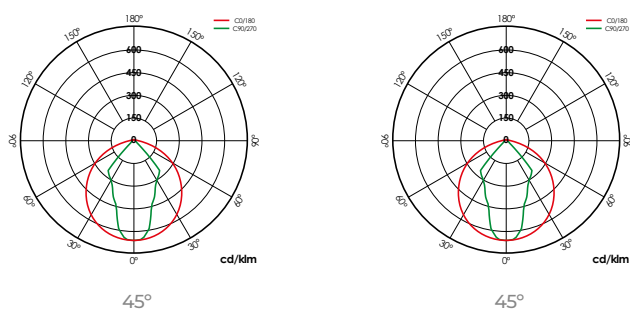

Bajo pedido

Aislamiento eléctrico

CII

Regulación



1-10V

Configuración

Kit de emergencia 1h









Kit de emergencia 3h

Sensor

Sensor de microondas



Especificaciones

	Garantía	Hasta 5 años de garantía
	Tensión (V)	220-240V ac
Hz	Frecuencia (Hz)	50-60Hz
Φ	Factor de potencia	>0,95
	Aislamiento eléctrico	Cl
	Índice de estanqueidad	IP65
	Resistencia al impacto	IK10
	Temp. de funcionamiento	-20°C~+70 °C
	Ángulo de apertura	45/55°
ϕ	Flujo luminoso (lm)	Hasta 38.400lm
K	Temperatura de color	4.000K
	Índice reproducción cromática	>80
	Vida útil	>50.000h
	L70B50>	L70>50.000h
	Color	-
	Difusor	VT-T: Vidrio templado transparente
	Cuerpo	AL: Aluminio

Modelo	Dimensiones	Peso
80W	1.150 x 86 x 178mm	4,1kg
100W	1.150 x 86 x 178mm	6,3kg
200W	1.430 x 86 x 178mm	7,9kg

Referencias

W_T	ϕ_T	ϕ/W	K	\leftrightarrow
80W	10.640lm	133lm/W	4 4.000K	1.150 x 86 x 178mm
100W	13.300lm	133lm/W	4 4.000K	1.150 x 86 x 178mm
200W	26.800lm	134lm/W	4 4.000K	1.430 x 86 x 178mm

Dimensiones

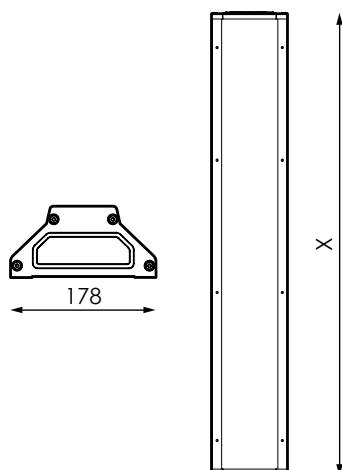

Fotometría

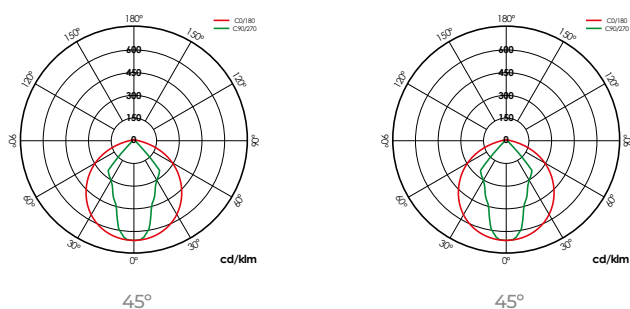

Bajo pedido

Aislamiento eléctrico

CII

Regulación



1-10V

Configuración

Kit de emergencia 1h

Kit de emergencia 3h

Sensor

Sensor de microondas



Especificaciones

	Garantía	Hasta 5 años de garantía
	Aislamiento eléctrico	Cl
	Tensión (V)	220-240V
Hz	Frecuencia (Hz)	50-60Hz
Φ	Factor de potencia	>0,95
	Temp. de funcionamiento	-20°C~+45 °C
ϕ	Flujo luminoso (lm)	Hasta 5.720lm
K	Temperatura de color	4.000K
	Índice reproducción cromática	>80
	Óptica	-
Δ	Ángulo de apertura	Ajustable 0°/115°
	Vida útil	50.000h
	L70B50>	50.000h
	Índice de estanqueidad	IP40
	Protección contra impactos	IK08
	Color	RAL 7035
	Difusor	PMMA: Polimetacrilato
	Cuerpo	Aluminio
	Dimensiones	-
	Posición de montaje	Superficie
		Suspender



Referencias

W_T	ϕ_T	ϕ/W		K	\leftrightarrow
35W	4.020lm	114lm/W	4	4.000K	1.200x140x58mm
35W	4.020lm	114lm/W	4	4.000K	1.500x140x58mm
50W	5.720lm	114lm/W	4	4.000K	1.500x140x58mm

Dimensiones

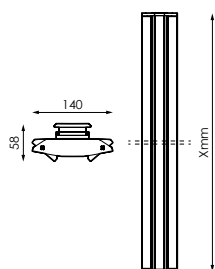

Fotometría

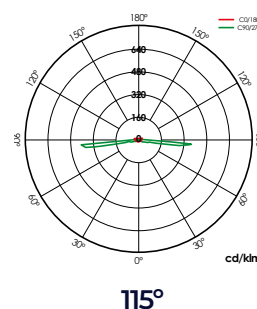
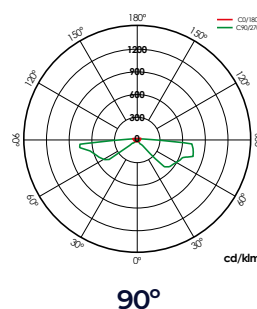
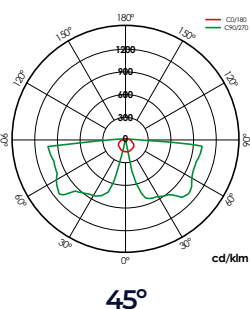
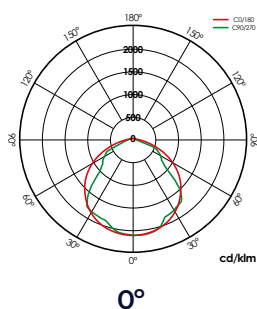

Bajo pedido

Regulación



Configuración

Kit de emergencia 1h

Kit de emergencia 3h

Accesorios

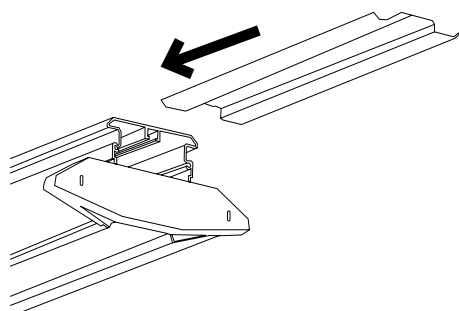

Kit de anclaje en línea continua

Fresh Salads



ALFARDO CHEESE	Price
4.200	1kg
7.900	1kg
15.000	1kg
32.700	1kg
35.400	1kg
38.700	1kg

Spaces



MADE IN EUROPE
playtech

SUPERFICIE / SUSPENDER



EMPOTRAR



Especificaciones



	Garantía	Hasta 5 años de garantía
	Aislamiento eléctrico	Cl
	Tensión (V)	220-240V
Hz	Frecuencia (Hz)	50-60Hz
Φ	Factor de potencia	>0,95
	Temp. de funcionamiento	-20°C~+45 °C
ϕ	Flujo luminoso (lm)	Hasta 5.600lm
K	Temperatura de color	4.000K
	Índice reproducción cromática	>80
	Óptica	-
Δ	Ángulo de apertura	120°
	Vida útil	50.000h
	L70B50>	50.000h
	Índice de estanqueidad	IP40
	Protección contra impactos	IK06
	Color	RAL 9005/9006/9016
	Difusor	Opal
	Cuerpo	AL: Aluminio
	Posición de montaje	Superficie/ Suspende
		Empotrar

Referencias

SUPERFICIE / SUSPENDER

W_T	ϕ_T	ϕ/W	K	\leftrightarrow	
20W	2.000lm	100lm/W	4.000K	50x70x500mm	19,2kg
36W	3.600lm	100lm/W	4.000K	50x70x1.000mm	19,10kg
36W	3.600lm	100lm/W	4.000K	50x70x1.200mm	19,10kg
56W	5.600lm	100lm/W	4.000K	50x70x1.500mm	27kg

EMPOTRAR

W_T	ϕ_T	ϕ/W	K	\leftrightarrow		
14W	1.512lm	108lm/W	4.000K	640x77x85	620x62mm	1,15kg
20W	2.200lm	110lm/W	4.000K	920x77x85	900x62mm	1,47kg
28W	3.024lm	108lm/W	4.000K	1.240x77x85	1.220x62mm	1,77kg
42W	4.494lm	107lm/W	4.000K	1.520x77x85	1.500x62mm	2,15kg

Dimensiones

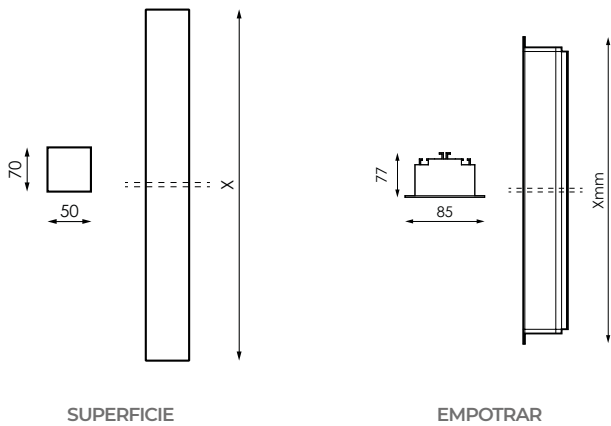

Fotometría

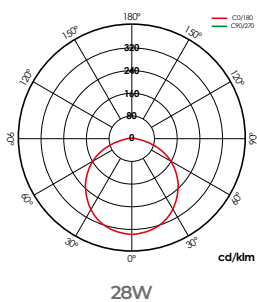

Bajo pedido

Regulación



1-10V

Configuración

Kit de emergencia 1h

Kit de emergencia 3h

Color

Disponibles colores RAL

Accesorios

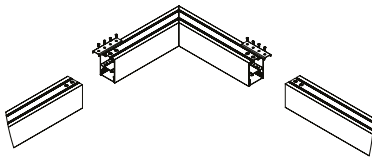

Lynx nova SUPERFICIE

Accesorio de conexión "L"

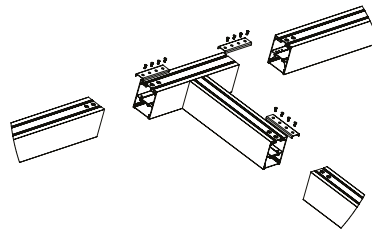

Lynx nova SUPERFICIE

Accesorio de conexión "T"

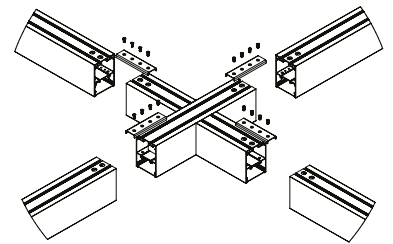

Lynx nova SUPERFICIE

Accesorio de conexión "X"





Especificaciones

	Garantía	Hasta 2 años de garantía
	Aislamiento eléctrico	Cl
	Tensión (V)	220-240V
Hz	Frecuencia (Hz)	50-60Hz
Φ	Factor de potencia	>0,9
	Temp. de funcionamiento	-20°C~+35°C
ϕ	Flujo luminoso (lm)	hasta 4.800lm
K	Temperatura de color	4.000K
	Índice reproducción cromática	>80
Δ	Ángulo de apertura	24°
	Vida útil	50.000h
	L70B50>	50.000h
	Índice de estanqueidad	IP20
	Color	Negro/Blanco
	Reflector	PC: Policarbonato
	Cuerpo	Metal
	Posición de montaje	Superficie
		Suspender

Referencias

W_T	ϕ_T	ϕ/W	K	\leftrightarrow
6W	600lm	100lm/W	4.000K	139x58x33mm
12W	1.200lm	100lm/W	4.000K	271x58x33m
24W	2.400lm	100lm/W	4.000K	536x58x33mm
36W	3.600lm	100lm/W	4.000K	801x58x33mm
48W	4.800lm	100lm/W	4.000K	1.066x58x33mm
48W	4.800lm	100lm/W	4.000K	1.266x58x33mm

Dimensiones

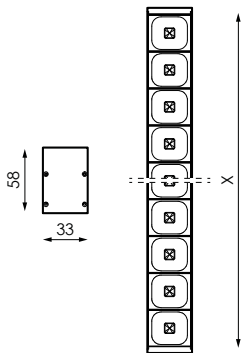

Fotometría

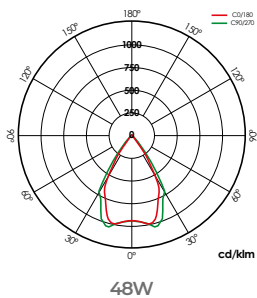

Bajo pedido

Regulación



1-10V

Configuración

Kit de emergencia 3h

Temperatura de color

3.000K



1x3W



2x6W



3x9W



4x12W

Especificaciones

	Garantía	Hasta 2 años de garantía
	Aislamiento eléctrico	Cl
	Tensión (V)	220-240V
Hz	Frecuencia (Hz)	50-60Hz
Φ	Factor de potencia	>0,9
	Temp. de funcionamiento	-20°C~+35 °C
ϕ	Flujo luminoso (lm)	Hasta 1.080lm
K	Temperatura de color	4.000K
	Índice reproducción cromática	>80
Δ	Ángulo de apertura	24°
	Vida útil	50.000h
	L70B50>	50.000h
	Índice de estanqueidad	IP20
	Color	RAL 9005/9006
	Reflector	PC: Policarbonato
	Cuerpo	AL: Aluminio
	Posición de montaje	Superficie
	Unidad de Embalaje	1

Referencias

$\frac{\phi}{\Delta O}$	W_T	ϕ_T	ϕ/W	K	\leftrightarrow	$\frac{O}{kg}$
1x	3W	270lm	90lm/W	4.000K	57x43x43mm	0,15kg
2x	6W	540lm	90lm/W	4.000K	57x43x73mm	0,19kg
3x	9W	810lm	90lm/W	4.000K	57x43x103mm	0,24kg
4x	12W	1.080lm	90lm/W	4.000K	57x103x73mm	0,32kg

Dimensiones

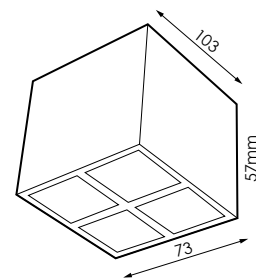
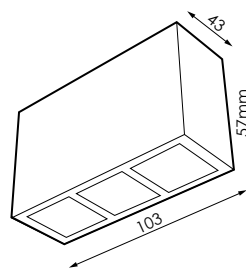
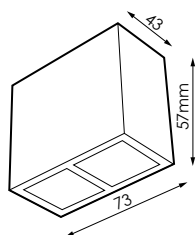
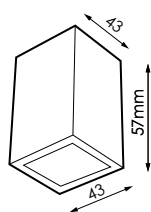

1x	2x	3x	4x
----	----	----	----

Fotometría

Regulación



1-10V

Configuración

Kit de emergencia 3h

Kit de emergencia 1h

Certificaciones
 Certifications
 Certifications
 Certificações



SGS ISO 9001



SGS ISO 14001



SGS ISO 45001



SGS ISO 50001

Condiciones de Uso
 Terms of use
 Condition d'utilisation
 Condições de uso

Condiciones de Garantía
 Warranty Conditions
 Conditions de garantie
 Condições de garantia

Condiciones de Venta
 Terms of sale
 Conditions de vente
 Condições de venda





PRILUX LIGHTING S.L.U.

SEDE CENTRAL

C/ Río Jarama nº 149.45007, Toledo (Spain).
Tel.: 925 23 38 12 / Fax: 925 23 38 80

DELEGACIÓN NORESTE

Carretera BV - 2249 Km 8
08791, Sant Llorenç d'Hortons, Barcelona (Spain).

Prilux eConcept Tel.: (+34) 93 891 37 24

Prilux Lighting S.L.U. Tel.: (+34) 93 719 23 29

www.prilux.es

DISEÑO GRÁFICO

Departamento de Marketing

Pueden aparecer variaciones con respecto al color original debido a causas técnicas de la impresión.

Este catálogo actualiza los valores y características de las mismas luminarias que aparezcan en anteriores catálogos.

Los datos incluidos en este catálogo son correctos salvo error tipográfico.

Prilux lighting S.L.U. se reserva el derecho a cualquier modificación del producto sin previo aviso.

Web

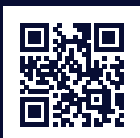



prilux.es

