

CARACTERÍSTICAS:

- Portalámparas G13.
- Estas luminarias están preparadas para tubo T8 de LED.

PRECAUCIONES:

- Desconecte la corriente antes de manipular el producto y reestablézcalo una vez finalizada la manipulación o instalación.
- Este producto debe ser instalado por personal cualificado, en caso de duda consulte con un técnico especializado.
- Manténgalo alejado de los niños.
- No manipule el producto con las manos mojadas.
- Para su almacenaje, guarde el producto en un sitio seco y protegido de golpes y humedad.
- Si la luminaria tiene fisuras o está dañada sustitúyala por una nueva.

INSTALACIÓN

1

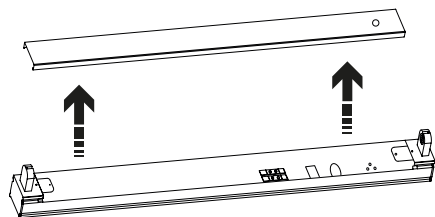

2

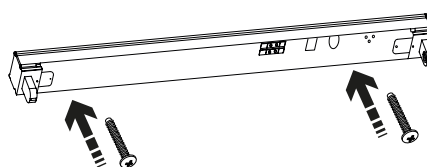

3

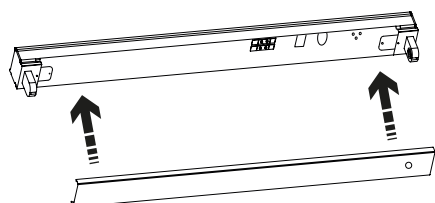

4

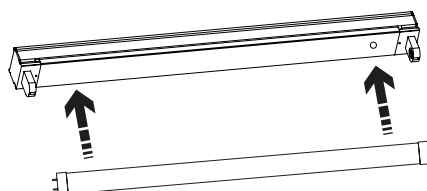

INSTRUCCIONES DE MONTAJE:

1. Desconecte la corriente
2. Practique unos agujeros en el techo de manera que estén a una distancia igual a la de los anclajes.
3. Retire la tapa de la luminaria.
4. Pase el conductor de alimentación a través del pasacables, y fije la luminaria a la superficie.
5. Conecte los cables a la borna de conexión, teniendo en cuenta que el cable verde-amarillo es el cable de conexión a tierra y está marcado con el símbolo: ⊕
6. Cierre la tapa.
7. Restablezca la corriente.

INSTALACIÓN DEL TUBO DE LED:

- Las regletas Argos LED están preparadas para ser instaladas con tubo T8 de LED alimentados a un extremo.

AVISO

ANTES DE COMENZAR LA INSTALACIÓN DE ÉSTE PRODUCTO, POR FAVOR, LEA ATENTAMENTE LAS INSTRUCCIONES Y GUÁRDELAS EN UN SITIO SEGURO. LA INSTALACIÓN DEBE REALIZARLA PERSONAL CUALIFICADO.

LA INADECUADA MANIPULACIÓN DE LOS COMPONENTES O DE LA PROPIA LUMINARIA PODRÍA DAÑAR EL CORRECTO FUNCIONAMIENTO DE ESTE PRODUCTO, QUEDANDO ANULADA LA GARANTÍA DEL FABRICANTE.



ATENCIÓN!!!

RESPECTAR LAS PRECAUCIONES DE MANIPULACIÓN DE LOS COMPONENTES SENSIBLES A DESCARGAS ELECTROSTÁTICAS (LED).

ALIMENTACIÓN

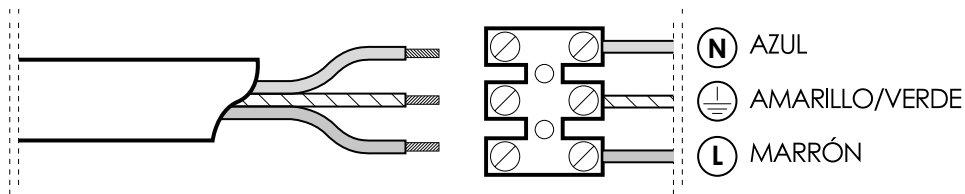

MODELO SIN POLARIDAD

Regleta sin polaridad 1x/2x para tubo con alimentación a un extremo y con el otro extremo puenteado.

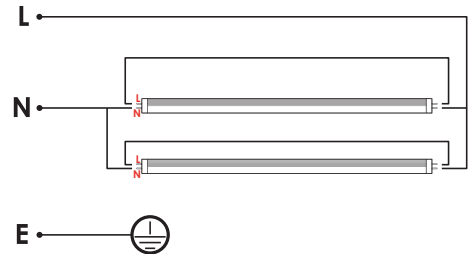
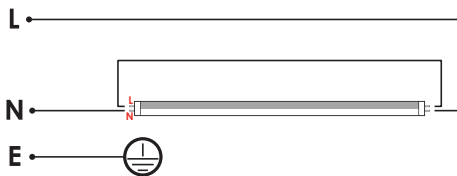

MODELO CON POLARIDAD

Regleta con polaridad 1x/2x para tubo con alimentación a un extremo y con el otro extremo puenteado.

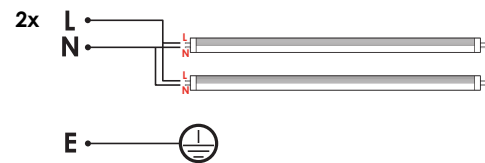
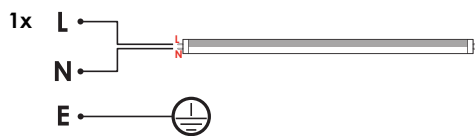
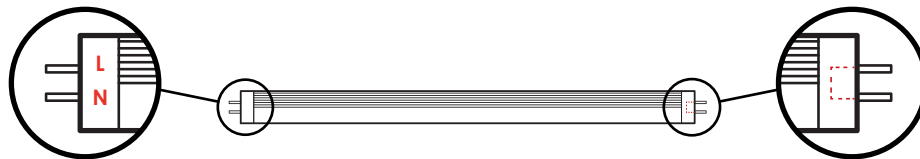
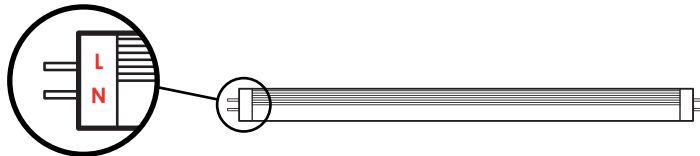

GRUPO PRILUX ILUMINACIÓN S.L.U.



SEDE CENTRAL

C/ Río Jarama nº 149
45007, Toledo (España)
Tel.: 925 23 38 12
Fax: 925 23 38 80

DELEGACIÓN NORESTE

Carretera BV - 2249 Km 8
08791, Sant Llorenç d'Hortons,
Barcelona (Spain)
Tel.: 93 719 23 29
Fax: 93 719 25 90

DELEGACIÓN LATAM

CNPJ: 16.863.522/0001-57
Rua das Castanheiras,
Nº 200 galpão 82,
Jardim São Pedro
CEP 13187-065
Hortolândia (SP)

Domicilio, Marcos Sastre 1769
5009, Bº Cerro de las Rosas,
Cordoba, (Argentina)



www.grupoprilux.com

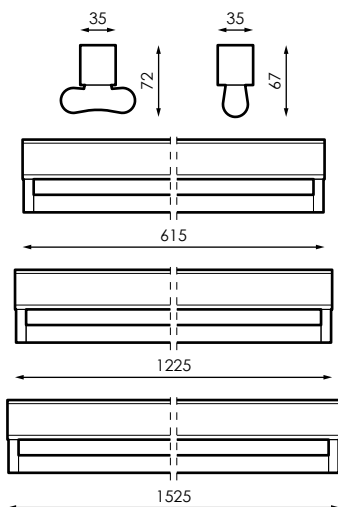
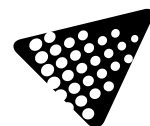

CHARACTERISTICS

- Lampholder G13.
- These luminaires are prepared for T8 LED tube.

PRECAUTIONS:

- Disconnect power before handling the product and reset the product after handling or installation is complete.
- This product must be installed by qualified personnel. If in doubt, consult a specialized technician.
- Keep him away from children.
- Do not handle the product with wet hands.
- For storage, store the product in a dry place protected from shock and moisture.
- If the luminaire is cracked or damaged, replace it with a new one.

ASSEMBLY INSTRUCTIONS:

1. Turn off the power
2. Drill holes in the ceiling so that they are at a distance equal to the distance of the anchors.
3. Remove the luminaire cover.
4. Pass the power cable through the cable gland and fix the luminaire to the surface.
5. Connect the cables to the connection terminal block, taking into account that the green-yellow cable is the grounding cable and is marked with the symbol: ⊕
6. Close the lid.
7. Restore power.

INSTALLATION OF THE LED TUBE:

- Argos LED strips are prepared to be installed with T8 LED tube supplied at one end. Either of these two positions is correct for the operation of the strip.

WARNING

BEFORE INSTALLING THIS PRODUCT, PLEASE READ THE INSTRUCTIONS CAREFULLY AND STORE THEM IN A SAFE PLACE. THE INSTALLATION SHOULD BE CARRIED OUT BY TRAINED STAFF. INCORRECT HANDLING OF THE PARTS OR THE LIGHT FIXTURE ITSELF MAY IMPAIR THE PROPER PERFORMANCE OF THIS PRODUCT. IN THIS CASE, THE MANUFACTURER GUARANTEE SHALL BE DEEMED VOID.

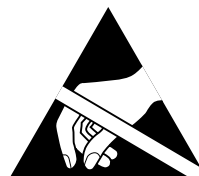

ATTENTION!!!

OBSERVE PRECAUTIONS FOR HANDLING ELECTROSTATIC SENSITIVE DEVICES.

INSTALLATION

1

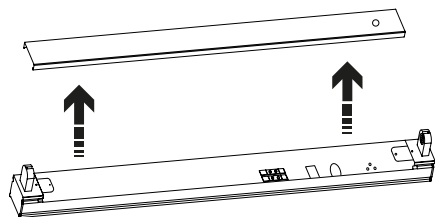

2

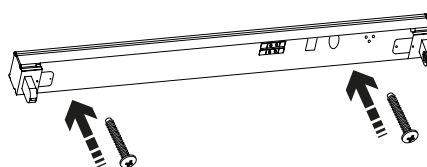

3

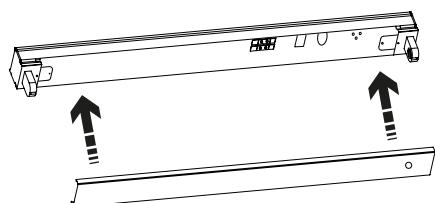

4

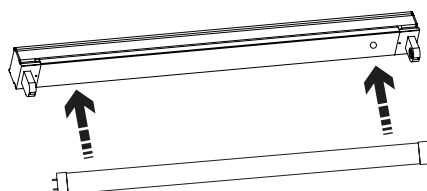

POWER SUPPLY

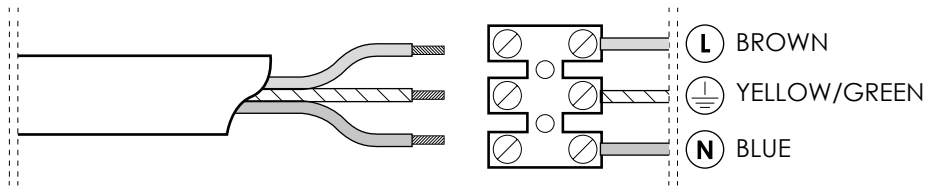

NON-POLAR MODEL

1x/2x non-polarity strip for tube with one end fed and the other end bridged.

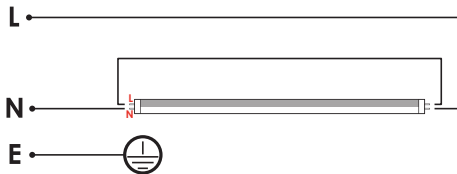
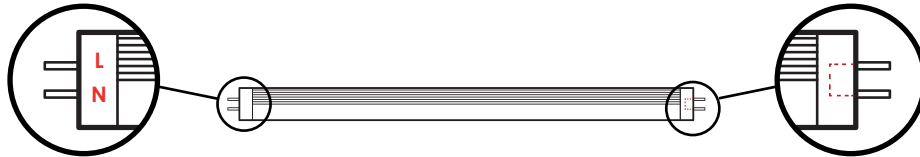

1x

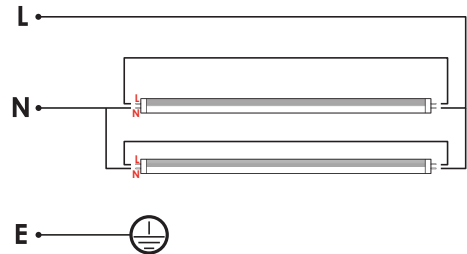

2x

POLARITY MODEL

1x/2x polarity strip for tube with one end feed and the other end bridged.

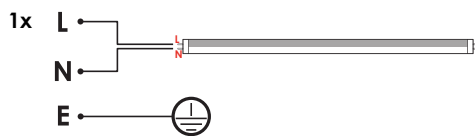
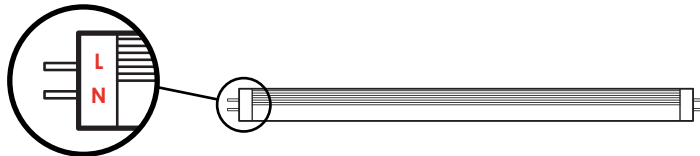

1x

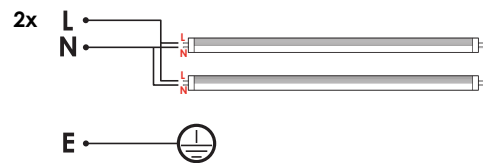

2x

GRUPO PRILUX ILUMINACIÓN S.L.U.



SEDE CENTRAL

C/ Río Jarama nº 149
45007, Toledo (España)
Tel.: 925 23 38 12
Fax: 925 23 38 80

DELEGACIÓN NORESTE

Carretera BV - 2249 Km 8
08791, Sant Llorenç d'Hortons,
Barcelona (Spain)
Tel.: 93 719 23 29
Fax: 93 719 25 90

DELEGACIÓN LATAM

CNPJ: 16.863.522/0001-57
Rua das Castanheiras,
Nº 200 galpão 82,
Jardim São Pedro
CEP 13187-065
Hortolândia (SP)

Domicilio, Marcos Sastre 1769
5009, Bº Cerro de las Rosas,
Cordoba, (Argentina)



www.grupoprilux.com